

# ANILAM

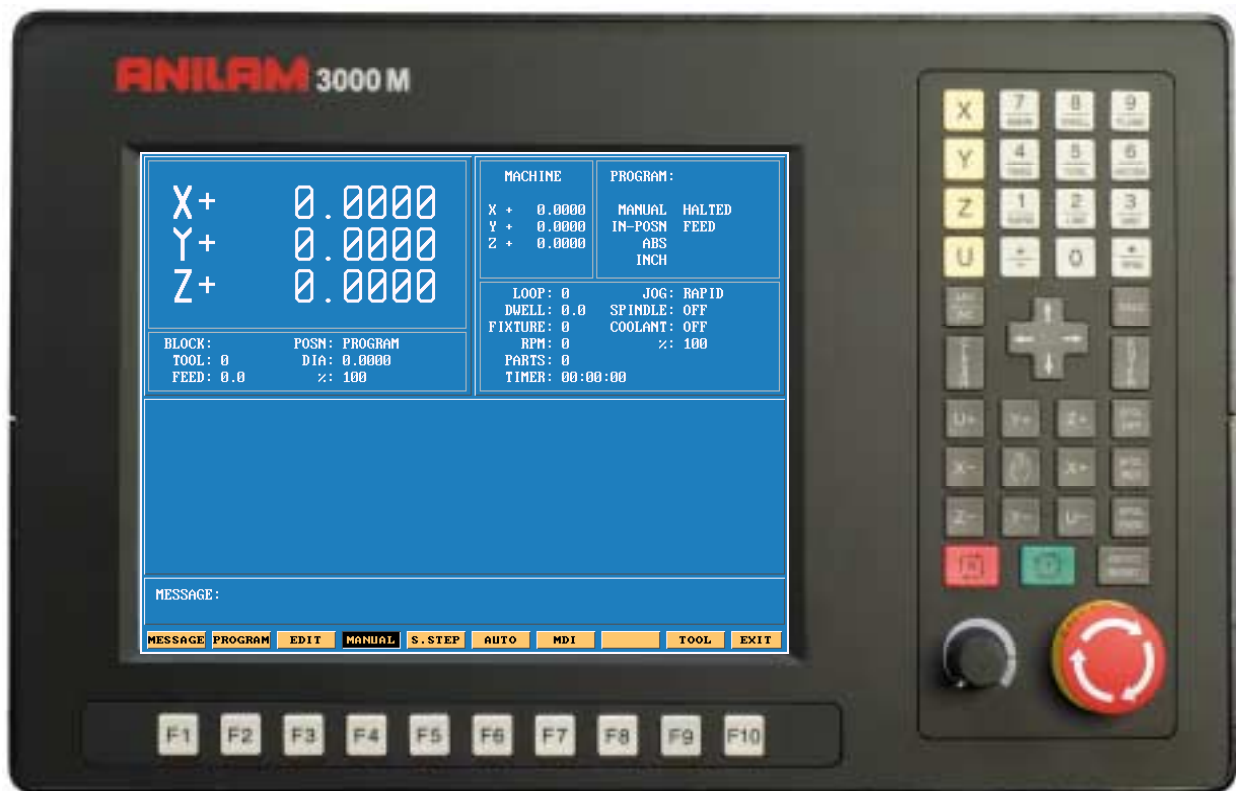

# ANILAM

## 3000M 3 Axis Training Guide

## 3000M CNC Control Training Guide

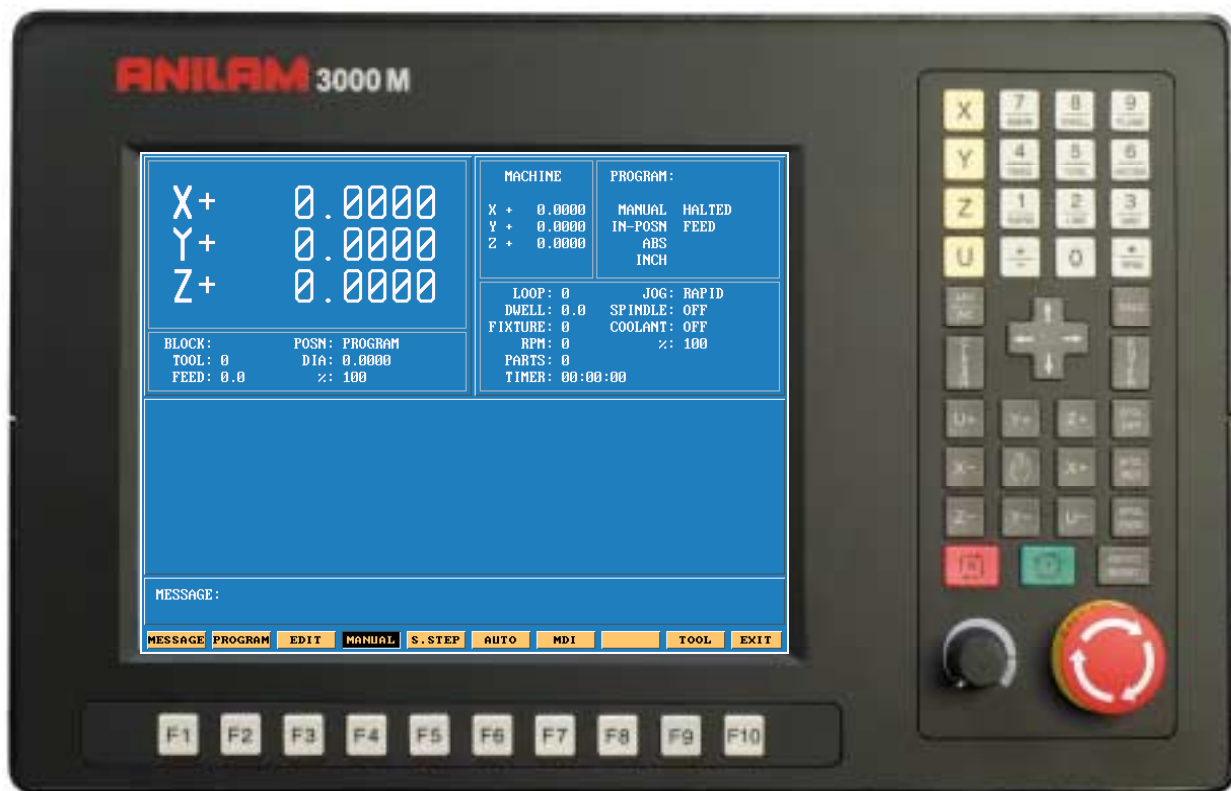

## Turning the Control ON

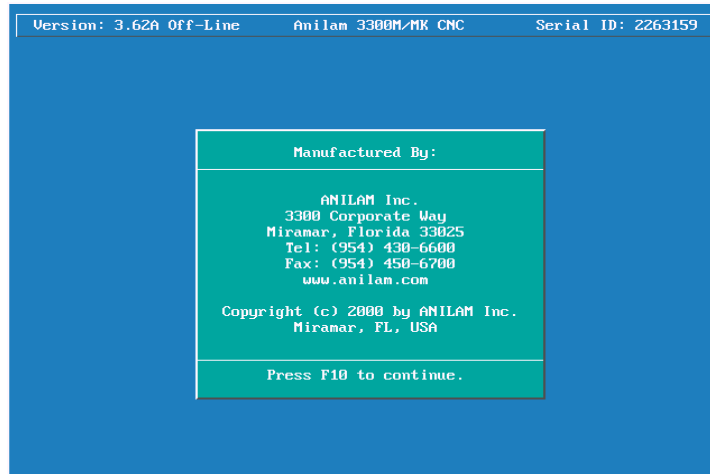

After the control has been turned ON press F10



to continue.

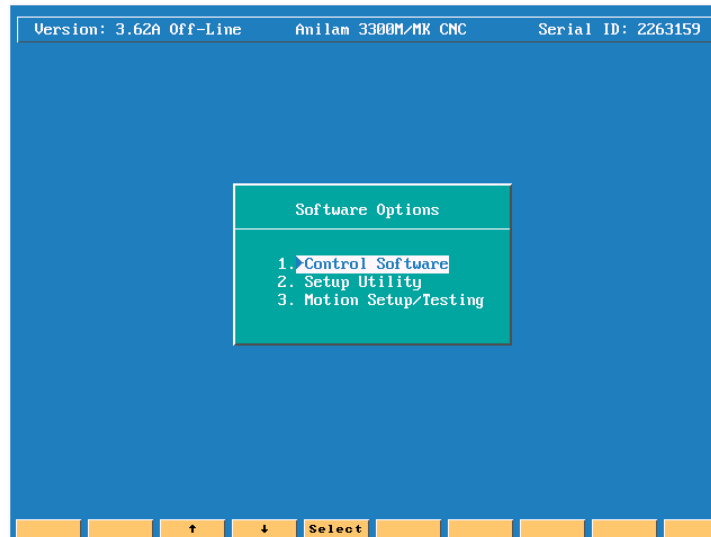

Then press



to select next page

# Main Areas of the Display

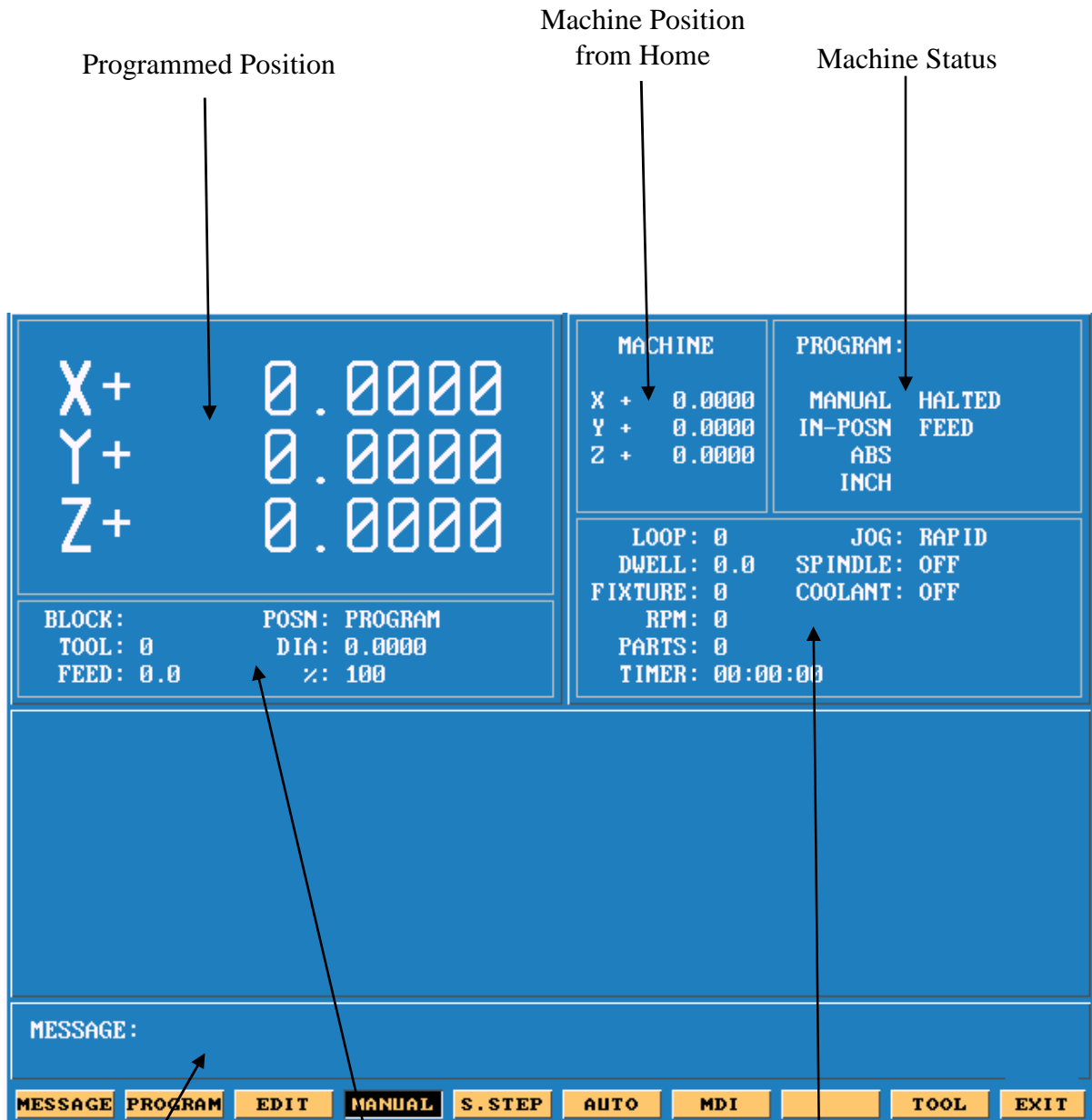

Message Area

Program & Tool information

Auxiliary Functions Information

## Areas of Main Screen

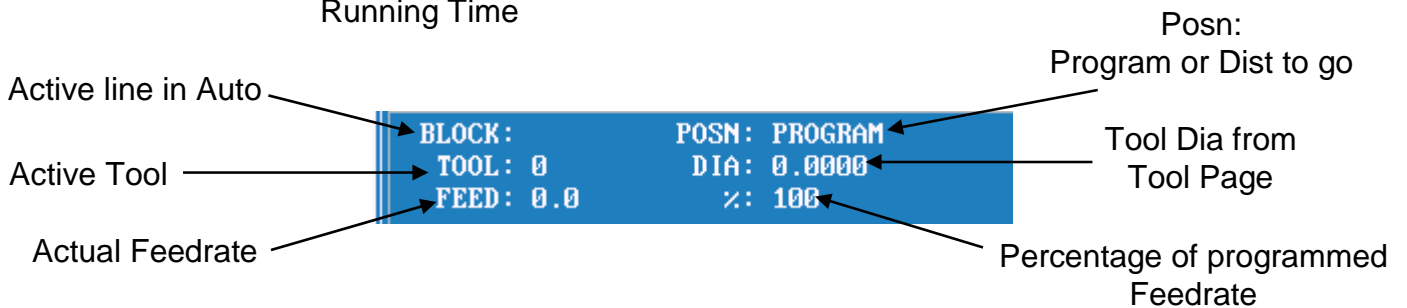
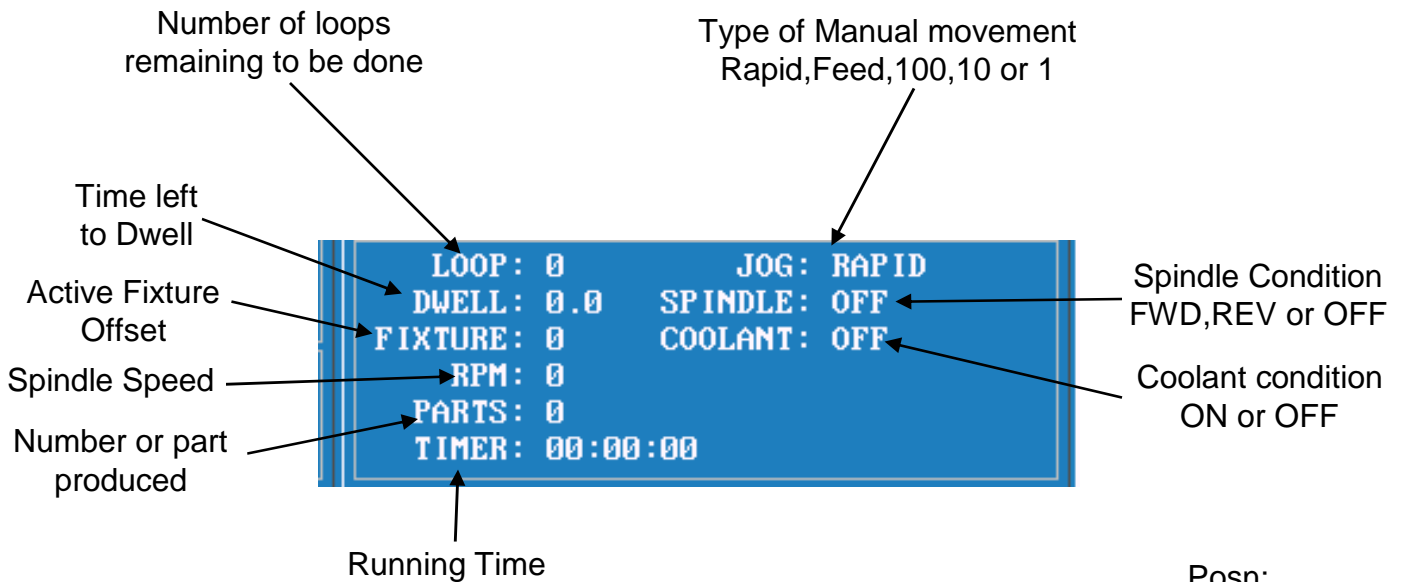
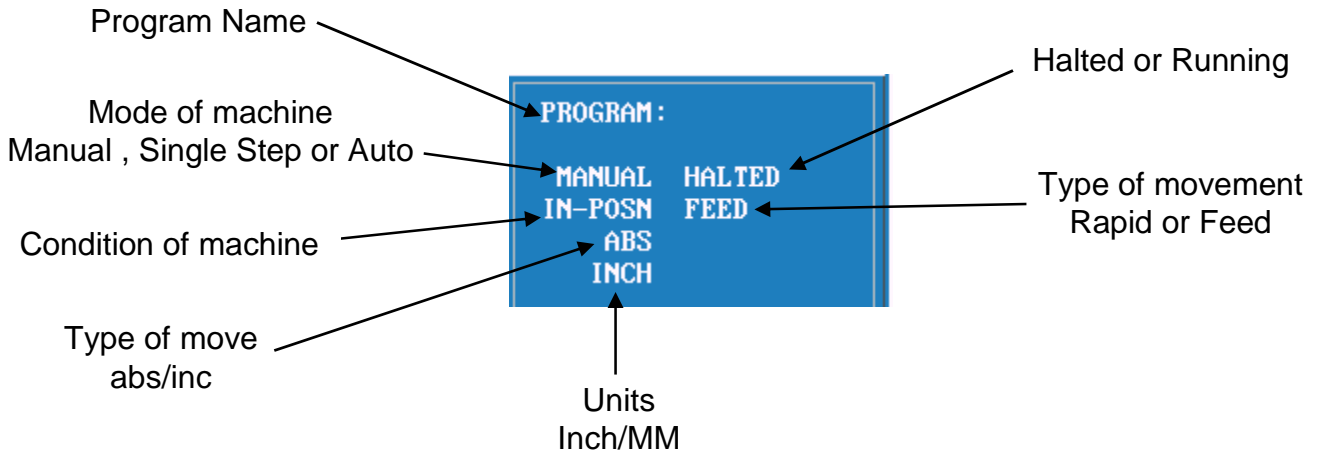

# Keyboard

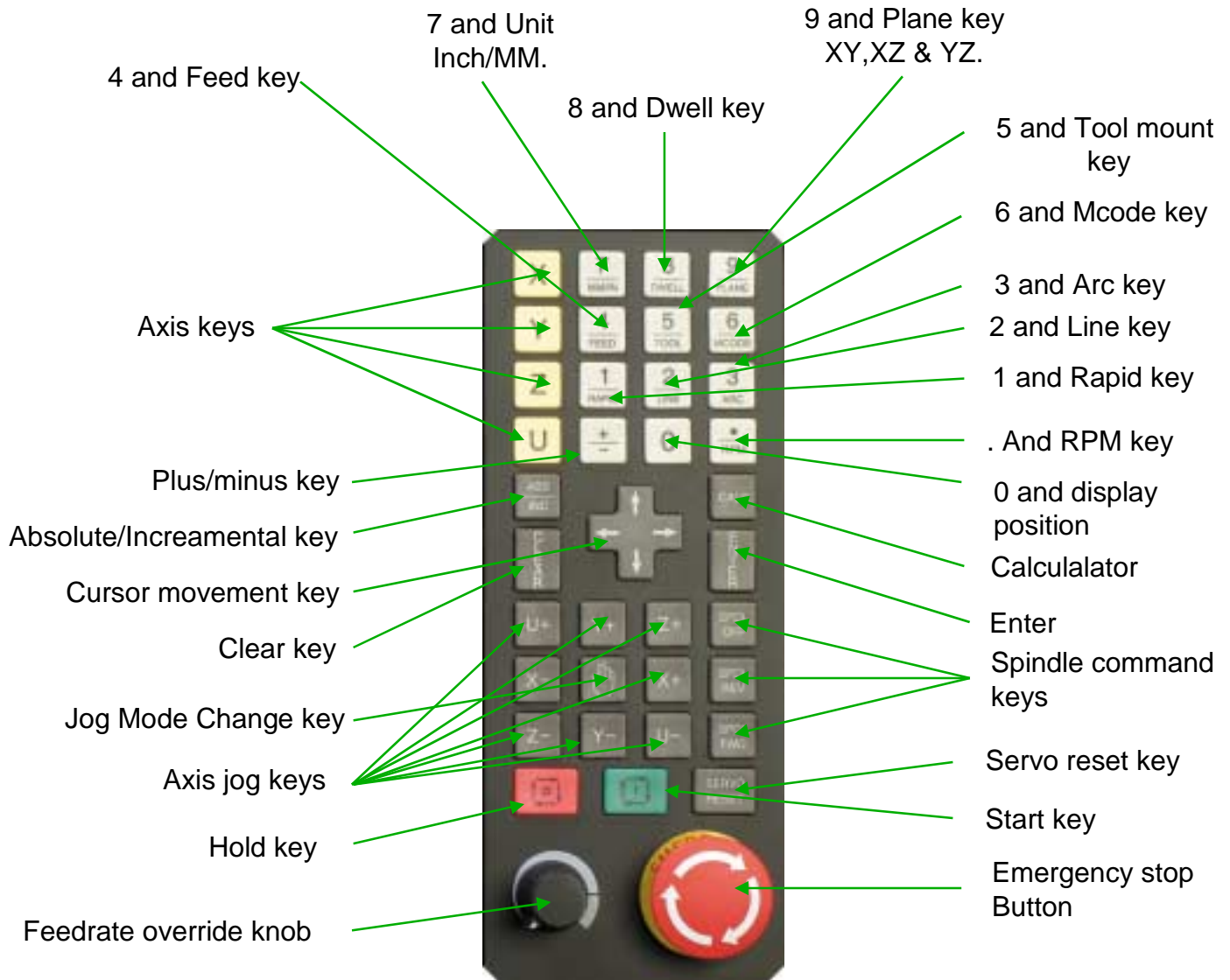

All the number key and the decimal point have dual functions as show above.

Along with the above we have “Hot Keys”

- |       |
|-------|
| 1     |
| Rapid |

 Accesses Rapid menus.
- |      |
|------|
| 2    |
| Line |

 Accesses Line menus.
- |     |
|-----|
| 3   |
| Arc |

 Accesses Arc menus.
- |      |
|------|
| 4    |
| Feed |

 Input feedrate.
- |      |
|------|
| 5    |
| Tool |

 Tool mount.
- |       |
|-------|
| 6     |
| MCode |

 Mcode inputs.
- |      |
|------|
| 7    |
| Unit |

 Inch/MM
- |       |
|-------|
| 8     |
| Dwell |

 Dwell in seconds
- |       |
|-------|
| 9     |
| Plane |

 Changes from XY,XZ or YZ.
- |   |
|---|
| 0 |
| * |

 If \* put in front of line in program ignores that line.
- |     |
|-----|
| ●   |
| RPM |

 Input for spindle speed if available.

# Function Keys

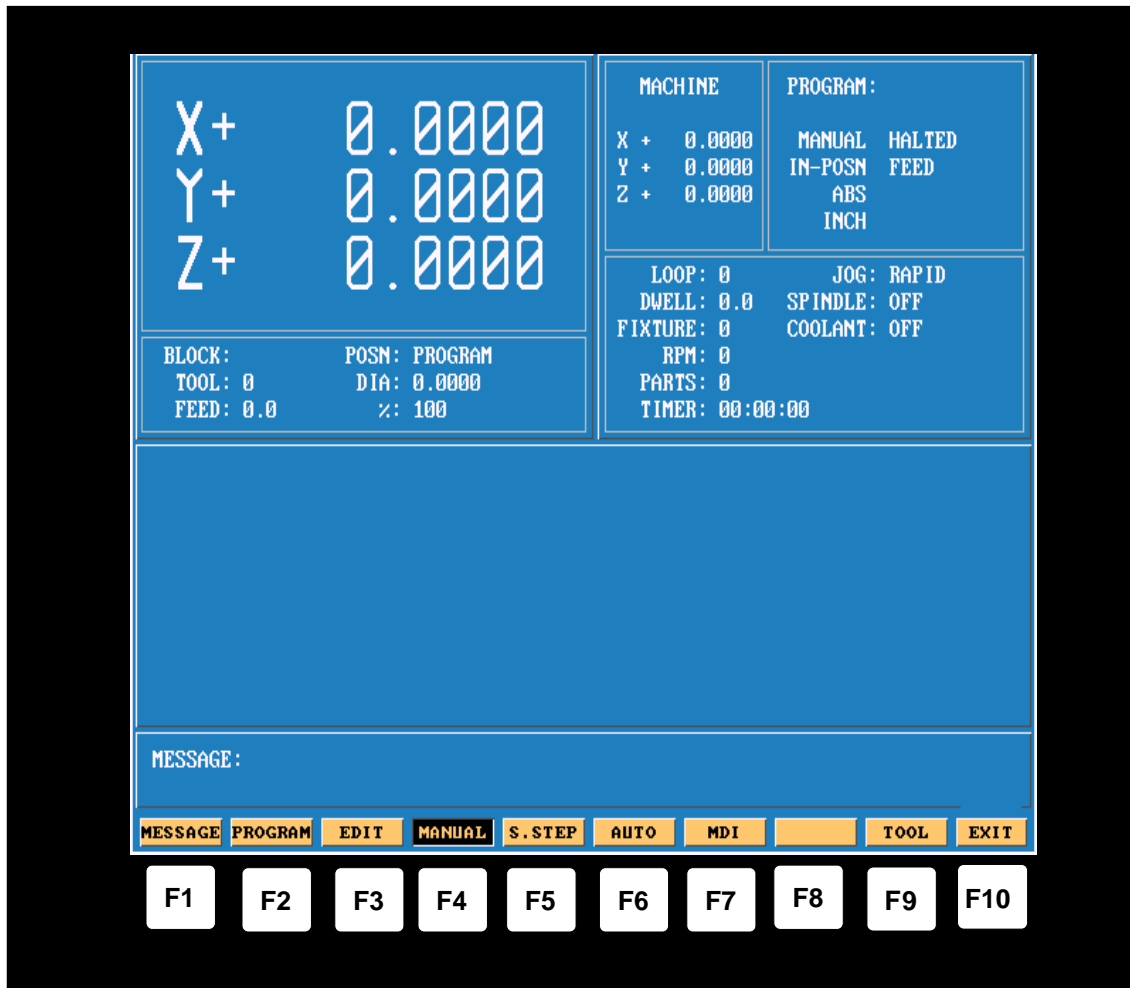

The Function (or F keys) activate the Mode shown directly above on the Display screen. The meaning of F keys change, depending upon what Mode of operation is selected.



An example of how F keys is shown above, this is how it would change when going from Manual to in Single Step or Auto.





<b>F1</b>	<b>Message</b>	Display last 8 messages that have appeared
<b>F2</b>	<b>Program</b>	Page at which program files are displayed
<b>F3</b>	<b>Edit</b>	Go to EDIT from Manual
<b>F4</b>	<b>Manual</b>	Manual mode of operation
<b>F5</b>	<b>S.Step</b>	Single step mode of operation
<b>F6</b>	<b>Auto</b>	Auto mode of operation
<b>F7</b>	<b>M D I</b>	Manual data input,allow operation without writing a program
<b>F8</b>		Not used
<b>F9</b>	<b>Tool</b>	Tool page and Fixture offsets can also be accessed from Edit
<b>F10</b>	<b>Exit</b>	Exits control software

## F1 Message Page

To enter message page press



This is how the messages will appear on the screen .  
When control is turned off the messages will be erased.

This is useful to tech's when trouble shooting problems on the control

```
Illegal program name!  
Illegal program name!  
Illegal program name!  
Press START to execute or MANUAL to Cancel.  
WARNING [Block 35]: Circle adjusted beyond maximum adjustment!
```

## Program Page

To enter page Press F2 **Program**



<b>F1</b>		Not used
<b>F2</b>	<b>Create</b>	This where new program names are type in.
<b>F3</b>	<b>Delete</b>	Delete an existing program.
<b>F4</b>	<b>Edit</b>	Programs are written and changed.
<b>F5</b>	<b>List</b>	Allows you to look at program but no Editing .
<b>F6</b>	<b>Select</b>	Picks program to be run.
<b>F7</b>	<b>Log</b>	Changes disk drive.
<b>F8</b>	<b>Display</b>	Changes how program page display program list
<b>F9</b>	<b>Utility</b>	Contains such utility as Copy ,Rename etc.
<b>F10</b>	<b>Exit</b>	Return to main screen in Manual Mode

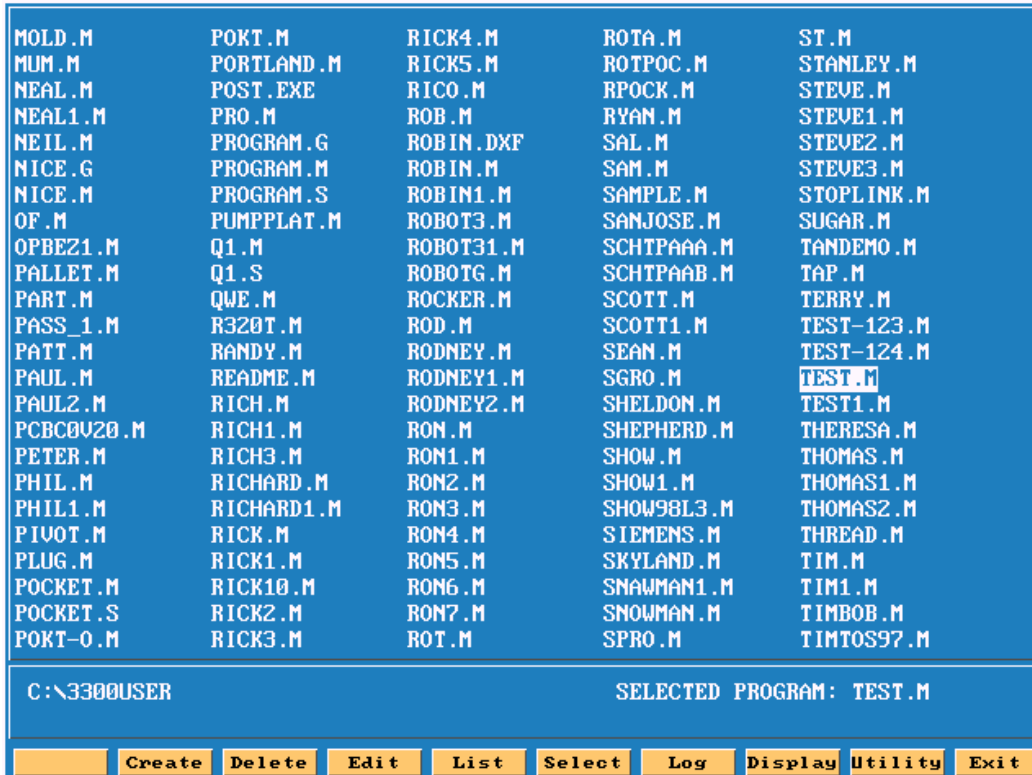

**Create**



When ASCII is pressed, this how the soft keys will look and a table will appear as show below  
 Using the arrow keys pick the letters then press the enter key. When complete press ASCII again and press enter, this will put program into the list of programs with .M extension and highlight will be on program that was just created.

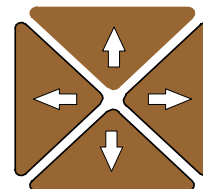
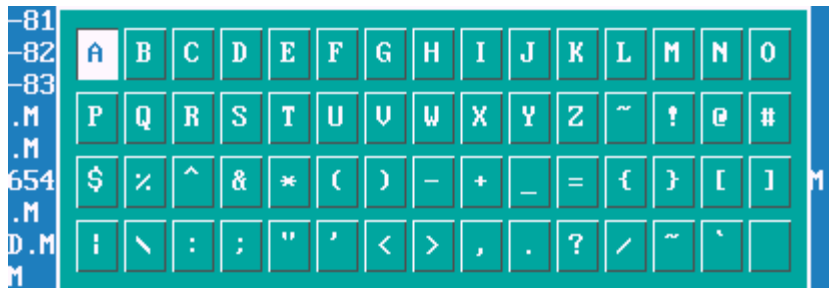

**E  
N  
T  
E  
R**

## Edit

When  is press, the screen appear as shown below.

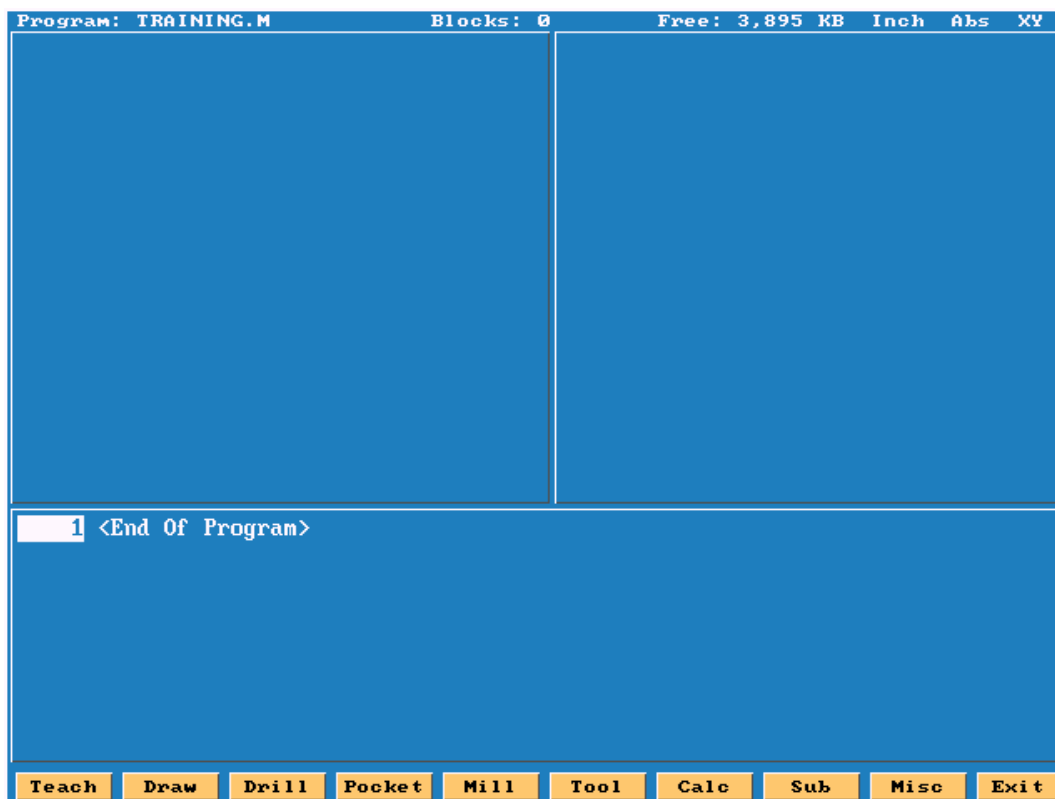

Pressing  allows user to look you to look at program only.

**Select**

MOLD.M	POKT.M	RICK4.M	ROTA.M	ST.M
MUM.M	PORTLAND.M	RICK5.M	ROTPC.M	STANLEY.M
NEAL.M	POST.EXE	RICO.M	RPOCK.M	STEVE.M
NEAL1.M	PRO.M	ROB.M	RYAN.M	STEVE1.M
NEIL.M	PROGRAM.G	ROBIN.DXF	SAL.M	STEVE2.M
NICE.G	PROGRAM.M	ROBIN.M	SAM.M	STEVE3.M
NICE.M	PROGRAM.S	ROBIN1.M	SAMPLE.M	STOPLINK.M
OF.M	PUMPLAT.M	ROBOT3.M	SANJOSE.M	SUGAR.M
OPBEZ1.M	Q1.M	ROBOT31.M	SCHTPAAA.M	TANDEMO.M
PALLET.M	Q1.S	ROBOTG.M	SCHTPAAB.M	TAP.M
PART.M	QWE.M	ROCKER.M	SCOTT.M	TERRY.M
PASS_1.M	R3Z0T.M	ROD.M	SCOTT1.M	TEST-123.M
PATT.M	RANDY.M	RODNEY.M	SEAN.M	TEST-124.M
PAUL.M	README.M	RODNEY1.M	SGRO.M	<b>TEST.M</b>
PAUL2.M	RICH.M	RODNEY2.M	SHELDON.M	TEST1.M
PCBC0U20.M	RICH1.M	RON.M	SHEPHERD.M	THERESA.M
PETER.M	RICH3.M	RON1.M	SHOW.M	THOMAS.M
PHIL.M	RICHARD.M	RON2.M	SHOW1.M	THOMAS1.M
PHIL1.M	RICHARD1.M	RON3.M	SHOW98L3.M	THOMAS2.M
PIVOT.M	RICK.M	RON4.M	SIEMENS.M	THREAD.M
PLUG.M	RICK1.M	RON5.M	SKYLAND.M	TIM.M
POCKET.M	RICK10.M	RON6.M	SNAWMAN1.M	TIM1.M
POCKET.S	RICK2.M	RON7.M	SNOWMAN.M	TIMBOB.M
POKT-0.M	RICK3.M	ROT.M	SPRO.M	TIMTOS97.M

C:\3300USER SELECTED PROGRAM: TEST.M

Create	Delete	Edit	List	Select	Log	Display	Utility	Exit
--------	--------	------	------	--------	-----	---------	---------	------

Program that is highlighted and then selected will shows up in this area. A program may be edited without being selected , but not run in Single step or auto.

# Display

```

054FIN.M    ARIEL.M    DALE.M    DELTA.M    FIL.M
054_CH1.M  BACKPUT.M  DALE1.M  DELTA1.M  FIX.M
123.M      BANTUM.M  DALE2.M  DELTA2.M  FORGE.M
221061A.M  BARNES.M  DAN.M    DENIS.M   FP.M
22PRGM1.M  BEN.M     DAN1.M   DIM.M     FRANK.M
2PRGM1.M  BERN.M    DANIEL.M DON.M     FRANK1.M
321.M      BILL.M    DAREN.M  DOUG.M    FRED.M
3300LET.M  BOB.M     DAREN1.M DOUG1.M   FRED1.M
442-8.M    BRIAN.M   DARRELL.M DOUG2.M   FRED2.M
442-81.M   BUTISL.M  DARRELL.M DOWNING.M FTR.M
442-82.M   CHEUSHOW.M DARRELL1.M EARNST.M  FX303.M
442-83.M   CHIP.M    DAVE.M   ED.M      GARY.M
456.M      CHRIS.M   DAVE1.M  ED2.M     GENE.M
543.M      CHUCK.M   DAVE10.M ED3.M     GEORGE.M
789654.M   CHUCK1.M  DAVE11.M ED4.M     GEORGE1.M
963.M      CHUCK2.M  EDDIE.M  GEORGE2.M GEORGE3.M
ABCD.M     CIR.M     DAVES.M  ELBOW.M   GEORGE3.M
ACCURACY.M CIRPOCK.M DAVE6.M  ELL.M     GEROTECH.M
AL.M       CONCORD.M DAVE7.M  ERU.M     GLORIA.M
ALAN.M     CP.M      DAVE8.M  ERU1.M    GLORIA1.M
AMT.M      CPU1.M    DAVE9.M  EXAM7.M   GOOFY.M
AMT2.M     CRAIG.M   DAVIS.M  FACE.M    GORDON.M
ANILAM.M   CRP.M     DD150CU.M FCP.M     GREG.M
APM42.M    CURT.M    DEAN.M   FEATHER.M GREG1.M
    
```

C:\3300USER SELECTED PROGRAM:

Create Delete Edit List Select Log Display Utility Exit

Normal screen only show .m files

```

054FIN.M    730,530  04/09/2001  02:38 pm
054_CH1.M  1,643,679 04/09/2001  01:13 pm
123.M      1,049    04/18/2001  03:38 pm
221061A.M  5,506    05/15/2001  02:18 pm
22PRGM1.M  60,626   05/15/2001  02:03 pm
2PRGM1.M  60,626   05/15/2001  02:03 pm
321.M      550      04/20/2001  03:07 pm
3300LET.M  8,991    11/18/1993  04:16 pm
442-8.M    699,105  12/13/2000  05:21 pm
442-81.M   666,091  12/13/2000  05:21 pm
442-82.M   697,377  12/11/2000  07:45 am
442-83.M   664,450  12/13/2000  05:21 pm
456.M      360      02/08/2001  09:45 am
543.M      121      11/29/2000  10:15 am
789654.M   257      01/16/2001  03:15 pm
963.M      279      10/25/2000  02:02 pm
ABCD.M     592      01/19/1999  03:14 pm
ACCURACY.M 772      05/15/2001  08:52 am
AL.M       540      11/25/1998  10:03 am
ALAN.M     374      07/07/2000  10:05 am
AMT.M      720      05/08/1997  09:15 am
AMT2.M     671      05/08/1997  01:56 am
ANILAM.M   3,339    11/17/2000  09:50 am
APM42.M    702      04/03/1998  04:28 pm
    
```

C:\3300USER SELECTED PROGRAM:

Create Delete Edit List Select Log Display Utility Exit

Show all in program files but show size of page program,date and time written

```

<DIR>      05/28/1998  11:06 am
11002AX\   <DIR>      05/28/1998  11:06 am
HYBCON     <DIR>      01/04/1999  02:29 pm
RICHARDN   <DIR>      09/19/2000  09:50 am
054FIN.M   730,530  04/09/2001  02:38 pm
054FIN.S   1,207,006 04/20/2001  09:27 am
054_CH1.M  1,643,679 04/09/2001  01:13 pm
054_CH1.S  2,074,788 04/20/2001  00:00 am
123.M      1,049    04/18/2001  03:38 pm
123.S      1,440    04/18/2001  03:38 pm
221061A.M  5,506    05/15/2001  02:18 pm
221061A.S  8,512    05/15/2001  02:30 pm
22PRGM1.M  60,626   05/15/2001  02:03 pm
2PRGM1.M  60,626   05/15/2001  02:03 pm
321.M      550      04/20/2001  03:07 pm
3300LET.M  8,991    11/18/1993  04:16 pm
485AXIS.DOC 1,508    04/20/2001  02:31 pm
442-8.M    699,105  12/13/2000  05:21 pm
442-8.S    1,268,388 04/12/2001  07:48 am
442-81.M   666,091  12/13/2000  05:21 pm
442-82.M   697,377  12/11/2000  07:45 am
442-83.M   664,450  12/13/2000  05:21 pm
456.M      360      02/08/2001  09:45 am
543.M      121      11/29/2000  10:15 am
    
```

C:\3300USER SELECTED PROGRAM:

Create Delete Edit List Select Log Display Utility Exit

Show only .m files but show size of program, date and time written

```

789654.M   CHIP.M    DAREN1.M  DOUG.M
963.M      CHRIS.M  DARRELL.M DOUG1.M
HYBCON     ABCD.M   CHUCK.M   DARRELL.M DOUG2.M
RICHARDN   ACCURACY.M CHUCK1.M  DARRELL1.M DOWNING.M
054FIN.M   ACCURACY.S CHUCK2.M  DAVE.M    EARNST.M
054FIN.S   AL.M     CIR.M     DAVE1.M   ED.M
054_CH1.M  ALAN.M   CIRPLES.DXF DAVE10.M  ED2.M
054_CH1.S  AMT.M    CIRPOCK.M DAVE11.M  ED3.M
123.M      AMT2.M   CLOVER.DXF DAVE2.M   ED4.M
123.S      ANILAM.DXF COMPLEX.DXF DAVES.M   EDDIE.M
221061A.M  ANILAM.M CONCORD.M  DAVE6.M   ELBOW.M
221061A.S  APM42.M  CP.M      DAVE7.M   ELL.M
22PRGM1.M  ARIEL.M  CPU1.M    DAVE8.M   ERU.M
2PRGM1.M  BACKPUT.M CRAIG.M   DAVE9.M   ERU1.M
321.M      BANTUM.M CROSS.DXF  DAVIS.M   EXAM7.M
3300LET.M  BARNES.M CRP.M     DD150CU.M FACE.G
485AXIS.DOC BEN.M    CURT.M    DEAN.M    FACE.S
442-8.M    BERN.M   DALE.M    DELTA.M   FACE.S
442-8.S    BILL.M   DALE1.M   DELTA1.M  FCP.M
442-81.M   BOB.M    DALE2.M   DELTA2.M  FEATHER.M
442-82.M   BRIAN.M  DAN.M     DENIS.M   FIL.M
442-83.M   BUTISL.DXF DAN1.M    DIM.M     FIX.M
456.M      BUTISL.M DANIEL.M  DOC1.DOC  FORGE.M
543.M      CHEUSHOW.M DAREN.M  DON.M     FP.M
    
```

C:\3300USER SELECTED PROGRAM:

Create Delete Edit List Select Log Display Utility Exit

Press display one time it will change to display all files in directory

## F keys there different functions.

First press **Create** type in a program name or number.

High light will be on program just created press **Edit**



<b>F1</b>	<b>Teach</b>	Let user move machine around and record positions.
<b>F2</b>	<b>Draw</b>	Draws program be running to see that it is correct.
<b>F3</b>	<b>Drill</b>	Access to drilling canned cycles.
<b>F4</b>	<b>Pocket</b>	Access to pocketing canned cycles.
<b>F5</b>	<b>Mill</b>	Access to milling features.
<b>F6</b>	<b>Tool</b>	Go to tool Page.
<b>F7</b>	<b>Calc</b>	Go to calculators.
<b>F8</b>	<b>Sub</b>	Sub more editing features.
<b>F9</b>	<b>Misc</b>	More editing features.
<b>F10</b>	<b>Exit</b>	Exits editing.



Press **F6** **Tool** This will bring up the **Tool Page**.

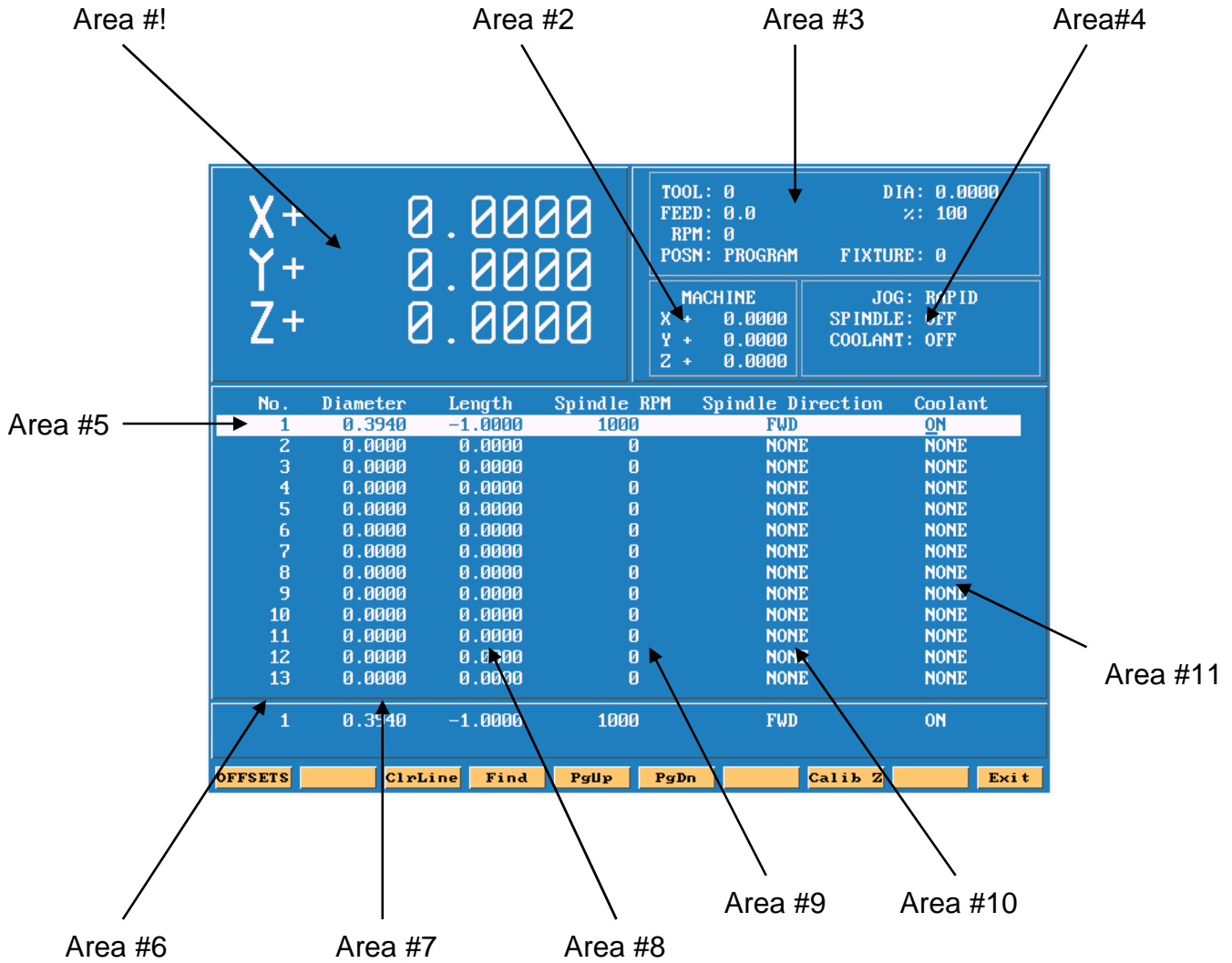

- Area #1** Machine position relative to part Zero.
- Area #2** Machine position relative to machine zero.
- Area #3** Tool information , Feed , RPM and Fixture offset.
- Area #4** Jog , spindle and Coolant condition.
- Area #5** Active line.
- Area #6** Tool number.
- Area #7** Tool diameter.
- Area #8** Tool length offset.
- Area #9.** RPM's only input if M-Functions or an inverter is installed.
- Area #10** Spindle forward or reverse same conditions as above apply.
- Area #11** Coolant on or off must have M-Functions.



<b>F1</b>	<b>OFFSET</b>	Go to FIXTURE OFFSET page
<b>F2</b>		Not used
<b>F3</b>	<b>ClrLine</b>	Clear highlighted line info.
<b>F4</b>	<b>Find</b>	Search for a tool.
<b>F5</b>	<b>PgUp</b>	Page up
<b>F6</b>	<b>PgDn</b>	Page down
<b>F7</b>		Not used
<b>F8</b>	<b>Calib Z</b>	Calibrate Z axis offset.
<b>F9</b>		Not used
<b>F10</b>	<b>Exit</b>	Exit to edit page when entered from edit page.

If entered from **MANUAL** page

**F10**

**Exit**

will exit to **MANUAL** page .

Press **F1** **OFFSET** this will take you to offset page.

<b>X+</b> 0.0000 <b>Y+</b> 0.0000 <b>Z+</b> 0.0000			TOOL: 0                   DIA: 0.0000 FEED: 0.0                 %: 100 RPM: 0 POSN: PROGRAM         FIXTURE: 0		
			MACHINE X + 0.0000 Y + 0.0000 Z + 0.0000	JOG: RAPID SPINDLE: OFF COOLANT: OFF	
No.	Diameter	Length	Spindle RPM	Spindle Direction	Coolant
1	0.3940				NONE
Fixture Offsets					
			X	Y	Z
1.			0.0000	0.0000	0.0000
2.			-20.0000	-6.0000	0.0000
3.			-9.0000	-6.0000	0.0000
4.			-6.0000	-6.0000	0.0000
5.			-3.0000	-6.0000	0.0000
6.			0.0000	-6.0000	0.0000
7.			0.0000	0.0000	0.0000
8.			0.0000	0.0000	0.0000
9.			0.0000	0.0000	0.0000
10	0.7500				NONE
11	1.0000				NONE
12	0.2180				NONE
13	0.0000				NONE
1	0.3940				NONE
			CalibX	CalibY	CalibZ
Exit					

All entries are taken from **Machine Home**.

Entries may be entered manually or by using **CalibX** or **CalibY**.

When doing manual input , select axis you wish to enter a value , by pressing that axis key and input number require press **ENTER**.

Using the **Calib** key move to required position and press desired calib axis key.

Press **F10** **Exit** to return to **Tool Page**

Press **F10** **Exit** to return to **Manual Page**

**Enter adjustment value** is an added feature that allows altering of existing values in the tool page or fixture offsets display. Use the **ABS/INC** Key to activate this feature.

No.	Diameter	Length	Spindle RPM	Spindle Direction	Coolant
1	* 2.0000	-2.0000	0	NONE	NONE
2	0.2500	-2.0000	0	NONE	NONE
3	0.1600	-2.0000	0	NONE	NONE
4	0.1400	-2.0000	0	NONE	NONE
5	0.1200	-2.0000	0	NONE	NONE
6	0.1000	-2.0000	0	NONE	NONE
7	0.0800	-2.0000	0	NONE	NONE
8	0.0600	-2.0000	0	NONE	NONE
9	0.0400	-2.0000	0	NONE	NONE
10	1.2500	-2.0000	0	NONE	NONE
11	1.0000	-2.0000	0	NONE	NONE
12	0.0000	0.0000	0	NONE	NONE
13	0.0000	0.0000	0	NONE	NONE

1 2.0000 -2.0000 0 NONE NONE  
 Enter adjustment value: -.125\_

ASCII Ins Del ← → BkSpace Cancel

**Example:** Altering tool diameter using **Enter adjustment value**.

\* Asterisk highlights the selected value.

No.	Diameter	Length	Spindle RPM	Spindle Direction	Coolant	
1					ONE	
2	Fixture Offsets				ONE	
3					ONE	
4		X	Y	Z	ONE	
5	1.	0.8000	1.3000	-19.0000	0.0000	ONE
6	2.	2.6000	1.1750	0.0000	0.0000	ONE
7	3.	0.8000	0.9000	0.0000	0.0000	ONE
8	4.	0.0000	0.0000	0.0000	0.0000	ONE
9	5.	2.8750	0.9250	0.0000	0.0000	ONE
10	6.	0.0000	0.0000	0.0000	0.0000	ONE
11	7.	0.0000	0.0000	0.0000	0.0000	ONE
12	8.	0.0000	0.0000	0.0000	0.0000	ONE
13					ONE	

1  
 Enter axis and adjustment value: X-1.250\_

ASCII Ins Del ← → BkSpace Cancel

**Example:** Altering fixture offsets using **Enter axis and adjustment value**

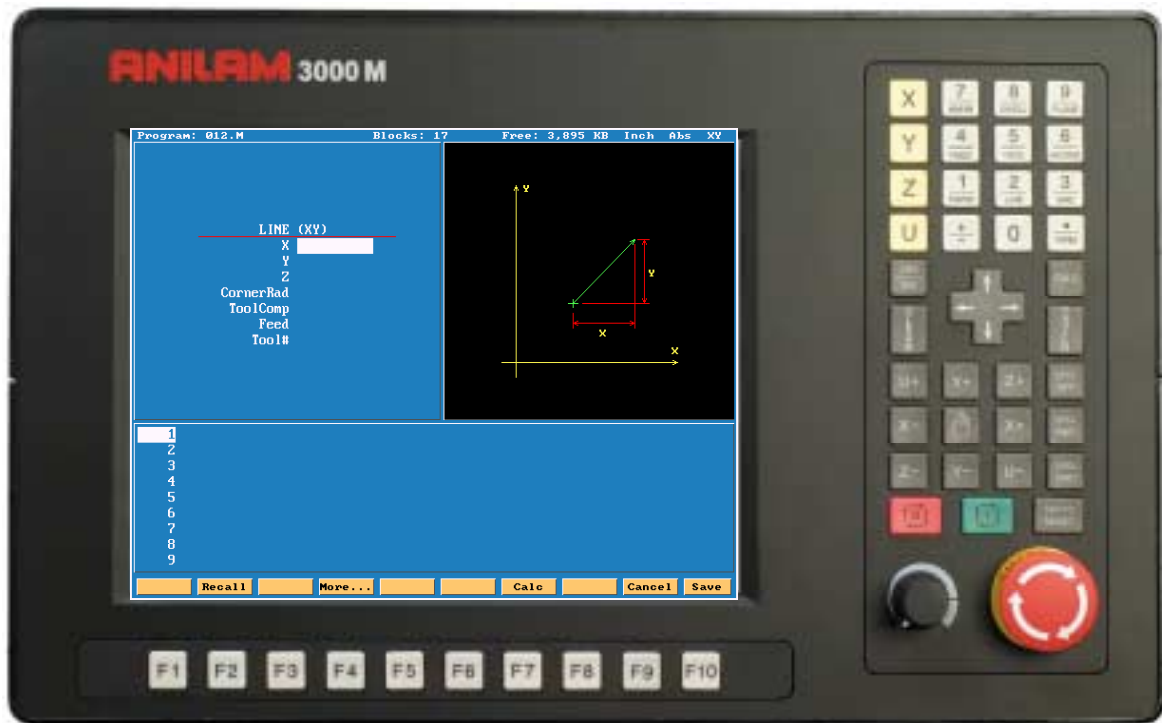

## 3000M CNC Control Lines and Arcs



## Lines and Arcs

Lines and arcs can be access in two ways .

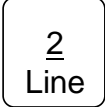
1. Using hot keys.

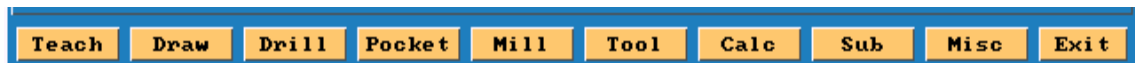

-  Accesses Rapid menus.
-  Accesses Line menus.
-  Accesses Arc menus.

2.Using soft keys



Press  



Press  



Press  

Screen will now show 6 icons , these apply to both rapid and line moves.

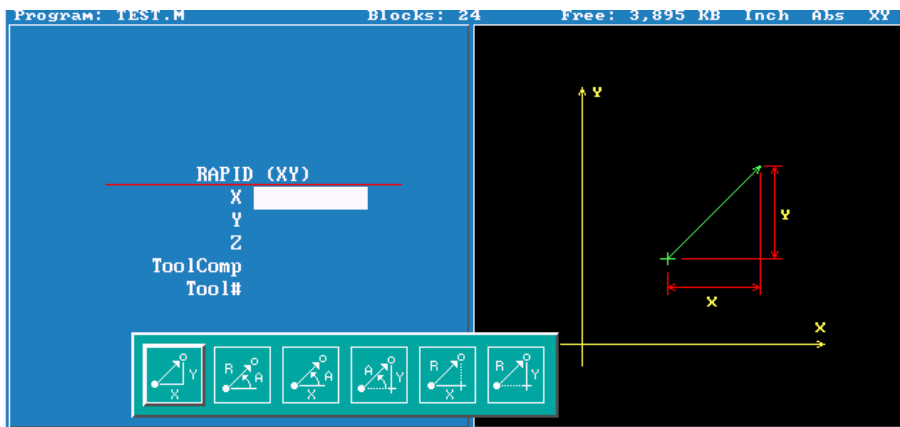

**Line** and **Rapid** are the same with one exception CornerRad and feed are not in rapid.

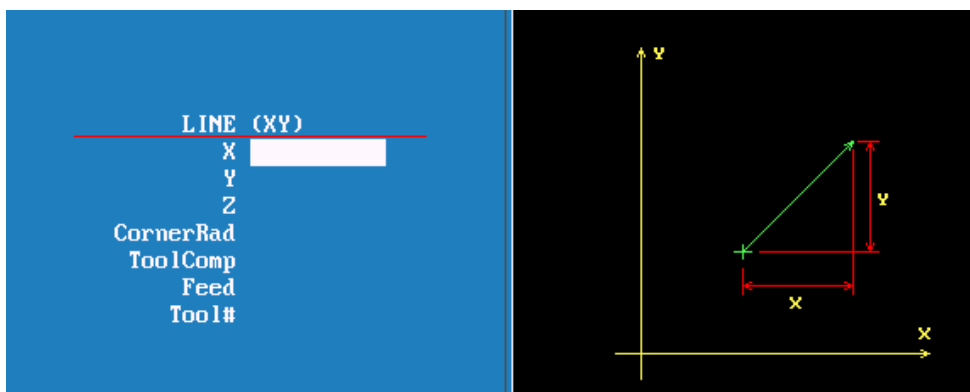

1. Enter coordinates in any or all axis.

2.

2. Using Radius and Angle from current position.

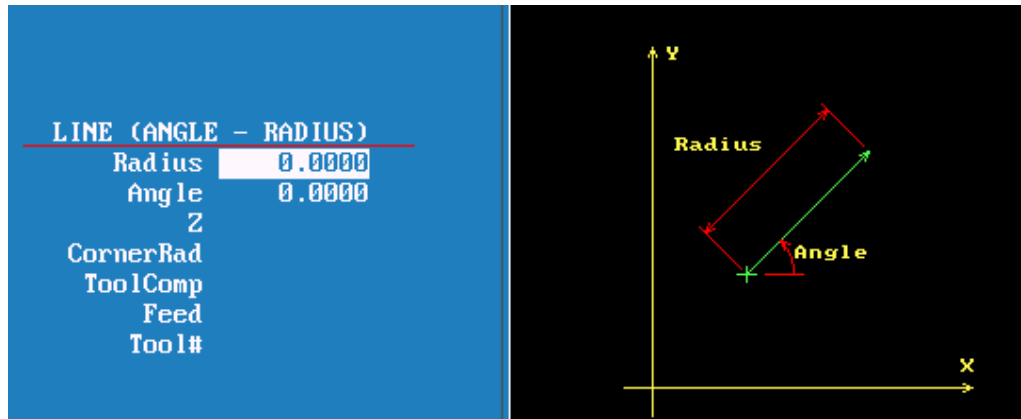

3. X axis move is an Absolute dimension, the Angle relative to Zero (three O'clock).  
Below it is Y axis and Angle.

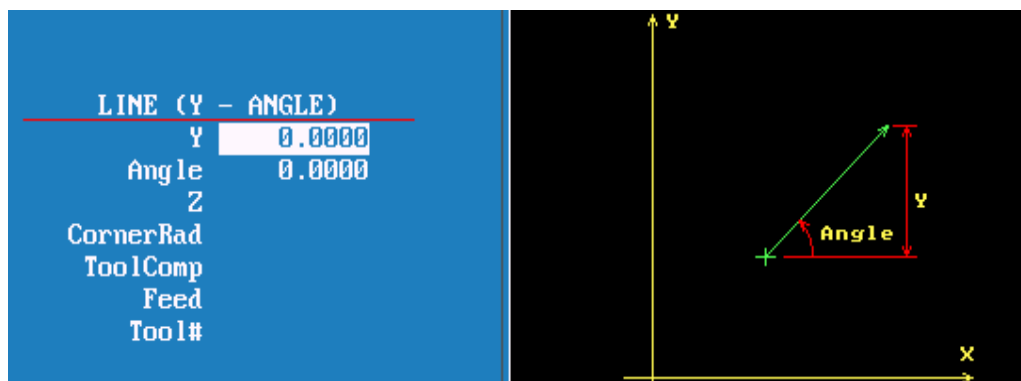
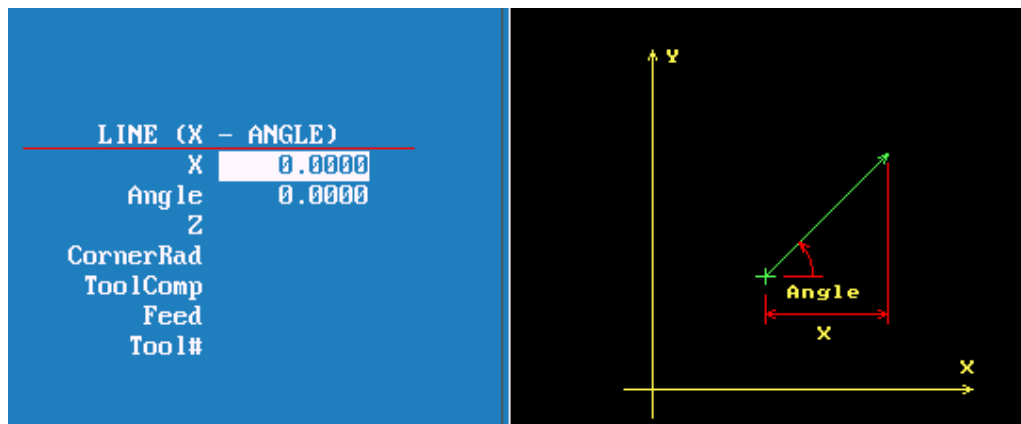

3.



4.Axis and Angle

If programming absolute X or Y dimension is from Part 0 and radius is from current position.

If programming incremental X or Y dimension and radius are from current position.

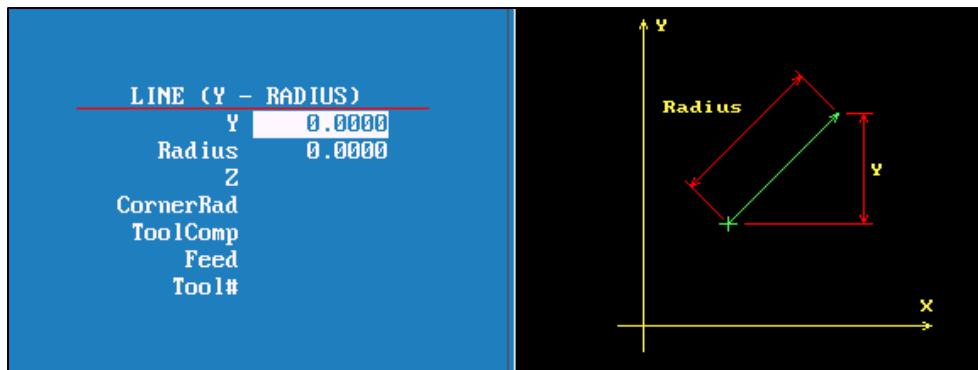
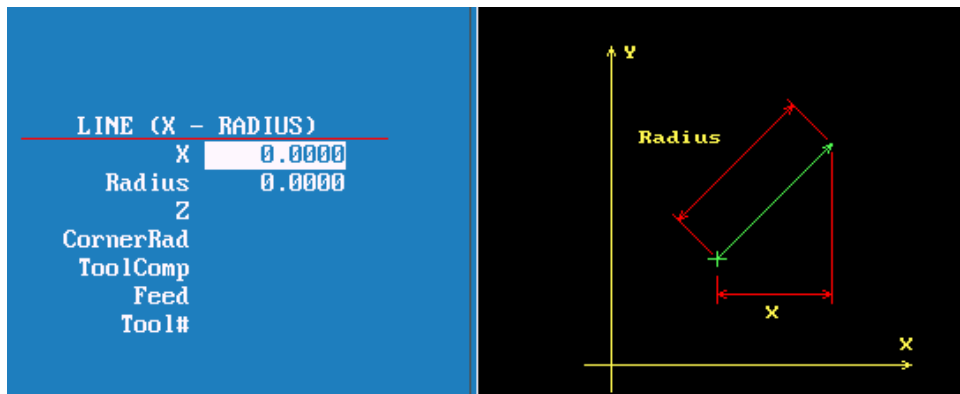



**F5**

**Mill**



**F4**

**Arc**



**F4**

**More...**

**The icon below are for arcs.**

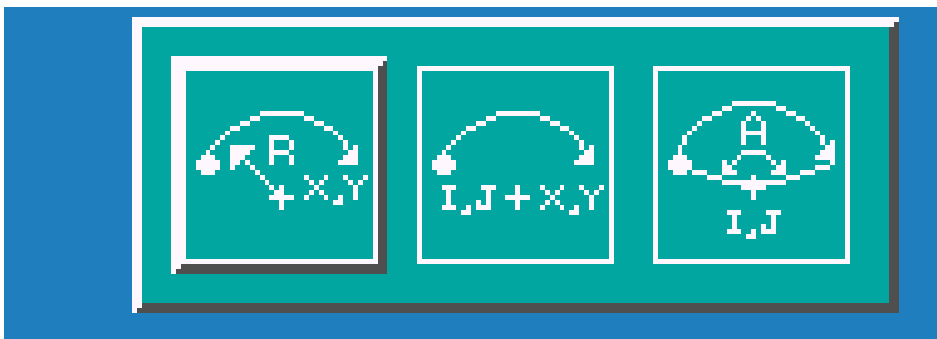

1

2

3

**Tool must be at start point of arc before it is programmed.  
Arc may be cut in any plane but must selected, default is XY.**

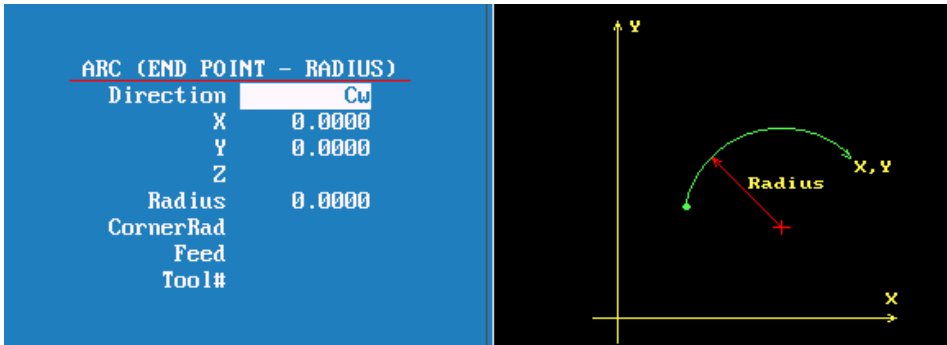

1. This is the default arc, End points for 2 axis and radius.  
 Direction is changed by pressing +/- key.  
 If programming an arc over 180 deg the radius is entered as a minus (-) value.

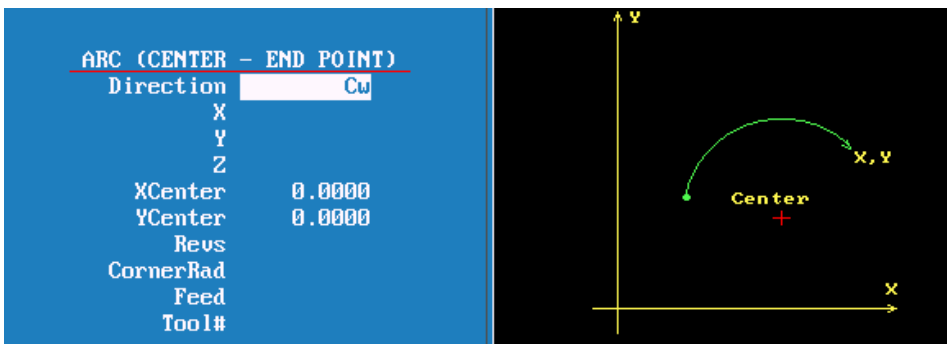

2. With this arc it is possible to mill a thread .  
 Enter X Y and Z end point , X Y center point and Number of Revolutions.  
 The pitch of thread is controlled by the Z movement and the number of revolutions.

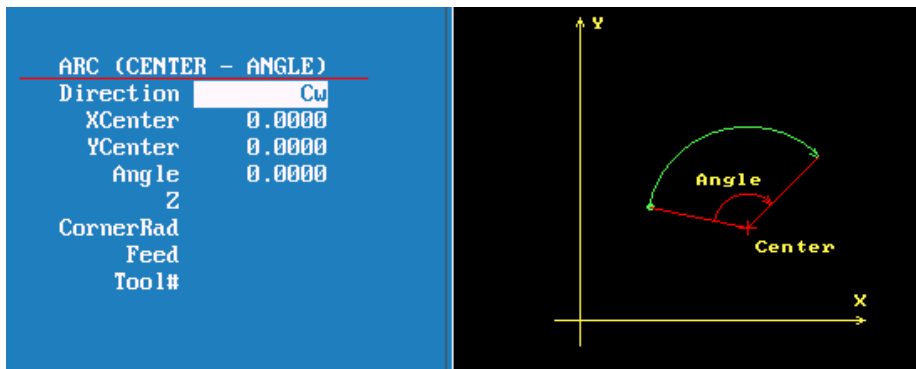

3.Center and angle

Programming absolute angle is from 3 o'clock position direction is also critical.

```

1 Rapid      X 0.7071 Y 0.7071
2 Arc Ccw   XCenter 0.0000 YCenter 0.0000 Angle 90.0000
3 <End Of Program>
    
```











The above lines of program starts at 45 deg's the center is X0, Y0 and go to 90 deg's in a counter clockwise direction, it will go to 12 o'clock, actually only moving 45 deg's. If direction was clockwise it would move 315 deg's.

```

1 Rapid      X 0.7071 Y 0.7071
2 Dim Incr
3 Arc Ccw   XCenter -0.7071 YCenter -0.7071 Angle 90.0000
4 Dim Abs
    
```

With the above program in incremental Counter clockwise will go from 45 deg's ,were it starting to 125 deg's, so it moves the actual number of degrees programmed. If clockwise is used it will go to -45 deg's , so it still only moves 90 deg's.



<b>F1</b>		Not used.
<b>F2</b>		Used to recall enters from calculator , will cover later.
<b>F3</b>		Not used.
<b>F4</b>		Used with Rapid , Line and Arc as shown previously .
<b>F5</b>		Not used.
<b>F6</b>		Not used.
<b>F7</b>		Calculator this will be cover later.
<b>F8</b>		Not used.
<b>F9</b>		Cancels what is being done .
<b>F10</b>		Saves information in to Program.

## 3000M CNC Control Canned cycles

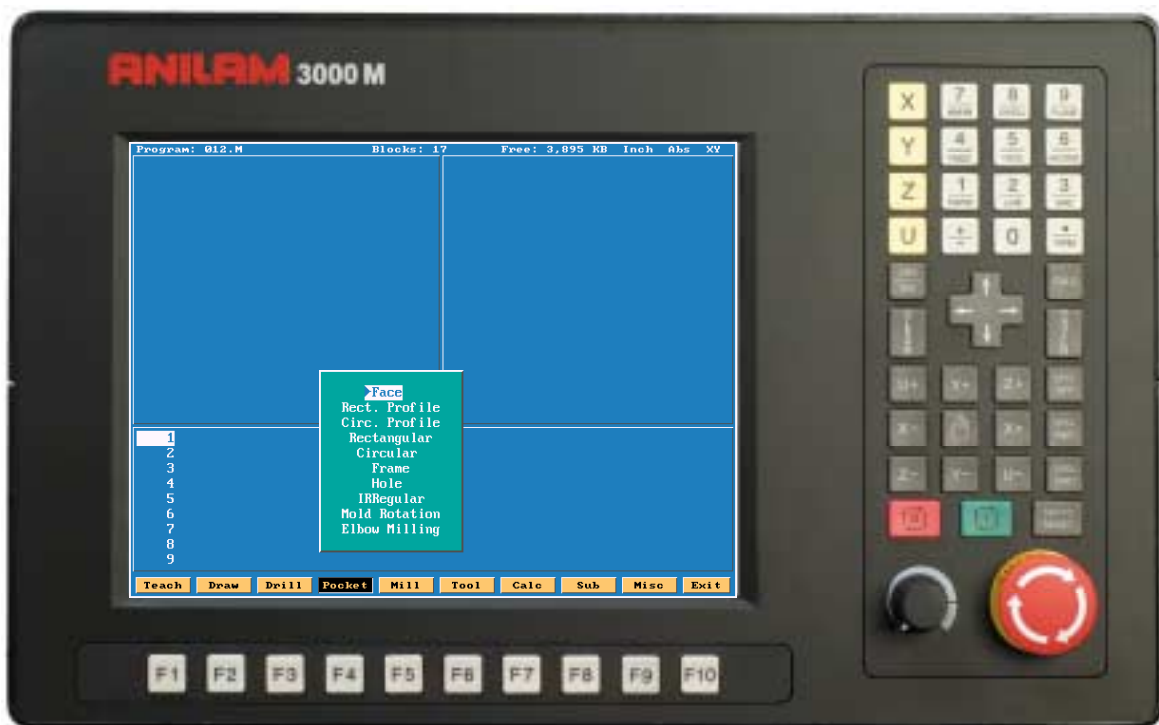

# Drill Canned Cycles & Patterns



1. Basic Rapid to Z start, Feed to Z depth, Rapid to Z return.
2. Pecking Rapid to Z start, Feed to peck, Rapid to Z start, Rapid to last peck, Repeat peck cycle to Z depth, Rapid to Z return.
3. Boring Rapid to Z start, Feed to Z depth, Dwell, Feed to Z start, Rapid to Z return.
4. Chip Break Rapid to Z start, Feed to first peck, Retract chip break Inc, Feed first peck minus peck decr, Retract chip break Inc, Repeat cycle until min peck is reached and continue to Z depth, Rapid to Z return.
5. Tapping Rapid to Z start, Feed to Z depth, Dwell, Reverse spindle, Feed to Z start, Rapid to Z return.
6. Pattern Drilling locations that can be defined into a symmetrical Pattern.
7. Bolt Hole Drilling locations that can be defined into a symmetrical Hole Pattern.

## Basic Drilling

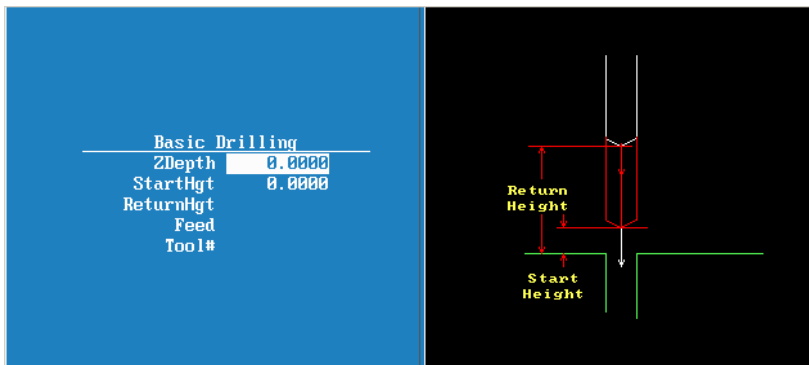

- ZDepth** Feed Z axis to depth.
- StartHgt** Rapid start of Z axis before feed to depth.
- ReturnHgt** Rapid return of Z axis from Z depth (Optional).
- Feed** Feed rate " Inches per minute" (Optional).
- Tool#** Activate new tool (Optional).

## Peck Drilling

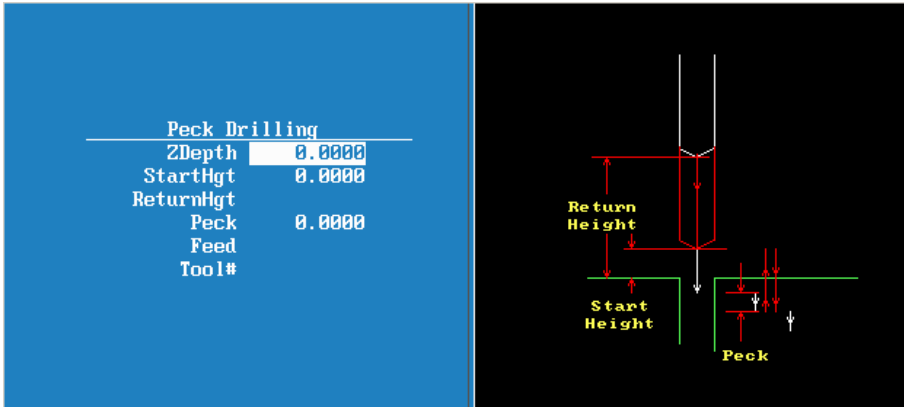

- ZDepth** Feed Z axis to depth.
- StartHgt** Rapid start of Z axis before feed to depth.
- ReturnHgt** Rapid return of Z axis from Z depth (Optional).
- Peck** Peck increment “ + Value”
- Feed** Feed rate “ Inches per minute” (Optional).
- Tool#** Activate new tool (Optional).

## Boring

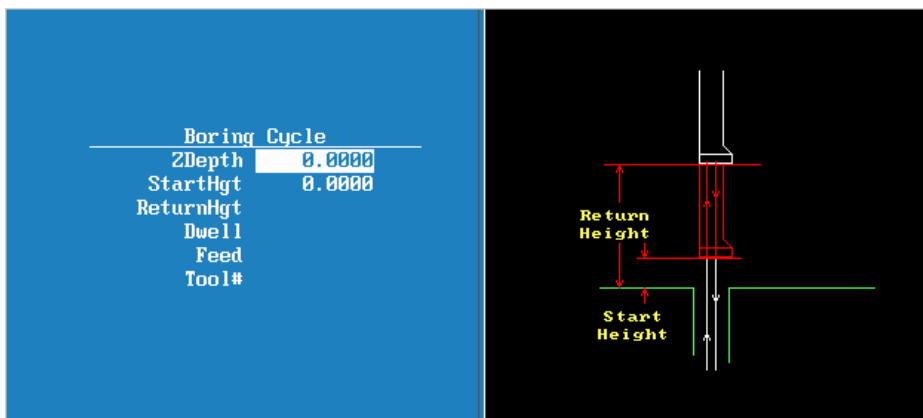

- ZDepth** Feed Z axis to depth.
- StartHgt** Rapid start of Z axis before feed to depth.
- ReturnHgt** Rapid return of Z axis from Z depth (Optional).
- Dwell** Dwell time at Z depth “Seconds” (optional)
- Feed** Feed rate “ Inches per minute” (Optional).
- Tool#** Activate new tool (Optional).



## Chip Break Cycle

Chip Breaking Cycle	
ZDepth	0.0000
StartHgt	0.0000
ReturnHgt	
FirstPeck	0.0000
PeckDecr	0.0000
MinPeck	0.0000
ChipBrkInc	
RetractDep	
Feed	
Tool#	

- ZDepth** Feed Z axis to depth.
- StartHgt** Rapid start of Z axis before feed to depth.
- ReturnHgt** Rapid return of Z axis from Z depth (Optional).
- FirstPeck** First unaltered pecking increment “ + Value”.
- PeckDecr** Decrement first peck each cycle “ + Value”.
- MinPeck** First peck altered to minimum value “ + Value”.
- ChipBrkInc** Retraction increment after peck “ + Value” (Optional).
- RetractDep** Retract to Z start and return to last peck at Retract Depth (Optional).
- Feed** Feed rate “ Inches per minute” (Optional).
- Tool#** Activate new tool (Optional).

## Tapping Cycle

Tapping Cycle	
ZDepth	0.0000
StartHgt	0.0000
ReturnHgt	
TPIorLead	0.0000
SyncSpin	No
Dwell	
Tool#	

- ZDepth** Feed Z axis to depth.
- StartHgt** Rapid start of Z axis before feed to depth.
- ReturnHgt** Rapid return of Z axis from Z depth (Optional).
- TPIorLead** Threads per inch or Lead to establish feed rate
- SyncSpin** Synchronize spindle with Z axis if so Equipped
- Dwell** Dwell at Z depth (Optional)
- Tool#** Activate new tool (Optional).

## Pattern Drill

Pattern Drill	
X	
Y	
#XHoles	0
#YHoles	0
XIncr	0.0000
YIncr	0.0000
Angle	

- X** X start location (Optional).
- Y** Y start location (Optional).
- #XHoles** Number of holes on X axis including starting hole.
- #YHoles** Number of holes on Y axis including starting hole.
- XIncr** Incremental distance between all holes on X axis "Use – or + values for direction".
- YIncr** Incremental distance between all holes on Y axis "Use – or + values for direction".
- Angle** Rotate entire pattern about X and Y starting hole (Optional).

## Bolthole Drill

Bolthole Drill	
XCenter	0.0000
YCenter	0.0000
#Holes	0
Diameter	0.0000
StartAngle	0.0000
EndAngle	
IndexAngle	

- XCenter** X center of circle.
- YCenter** Y center of circle.
- #Holes** Number of holes in circle including starting hole.
- Diameter** Diameter of circle.
- StartAngle** First hole angle from 3 o'clock zero ( 0 to 360 degrees counter clockwise) or ( + counter clockwise degree increment / - clockwise degree increment).
- EndAngle** End hole angle from 3 o'clock zero ( 0 to 360 degrees counter clockwise) or ( + CCW or – CW degree increment)\_\_\_\_\_ (EndAngle Optional).
- IndexAngle** Rotate entire pattern about circle center (Optional).

## Thread Milling Cycle

**WARNING:** The first move in this cycle is a rapid move to the center of the thread before moving the Z-axis. Make sure the tool is properly located before calling up this cycle.

Thread Milling Cycle simplifies the programming required to mill a thread. Use the thread milling for cutting inside or outside threads. It will cut either Inch or MM, left or right hand, and Z movement up or down. A single tooth or multi-toothed tool may be used. Start can be at the top or bottom of the hole or boss. Tool Length Offset is set the same as with any other tool or operation. A tool diameter also has to be set in the tool table, as cutter compensation is built into this cycle (cutter compensation is not allowed during the use of this cycle). The tool must be positioned at center of hole or boss, or the parameters for **XCenter** and **YCenter** must be specified in the cycle.

**XCenter**, **YCenter**, **ArcInRad**, **StockAmt**, **Passes**, **RoughFeed**, **FinFeed**, and **TaperAng** are all optional Input; all other parameters must be programmed. If the feed rates are not programmed, the CNC will use last feed rate used.

In a tapered thread the Major Diameter is always the major diameter of thread where the **ZStart** is set. Inside diameter is at finished depth and outside diameter is the diameter of boss.

To program a Thread Milling Cycle:

1. In Edit Mode, press **Drill (F3)** to display a pop-up menu.
2. Select **Thread Mill** from the pop-up menu, and press **ENTER** to display the **Thread Mill** Graphic Menu. Refer to **Figure 5-8**.

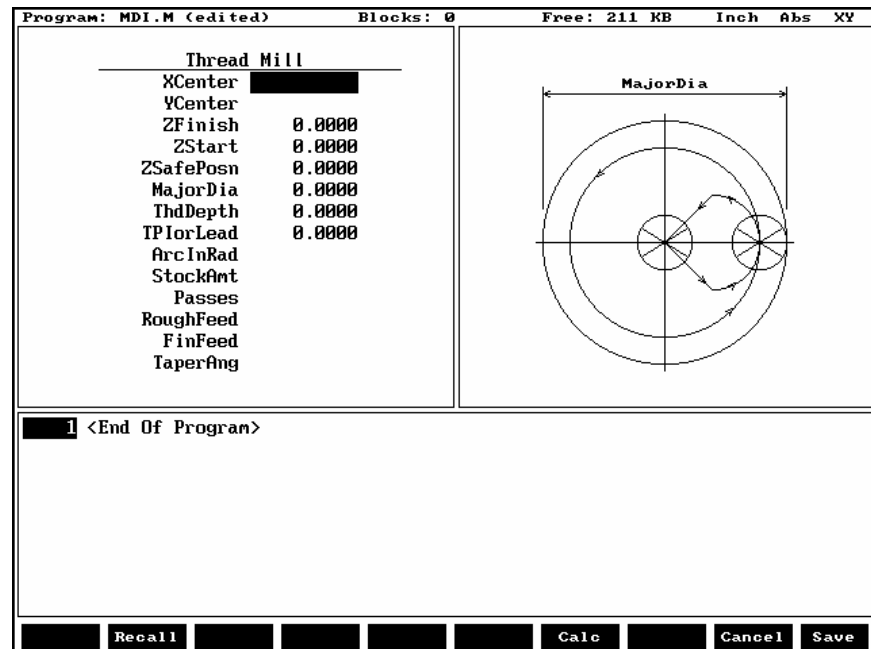

Figure 5-8, Thread Mill Graphic Menu

3. Enter the following required values and settings in the **Thread Mill** entry fields:

<b>XCenter</b>	Absolute X coordinate of the center of the thread. If no coordinate is entered, the CNC puts the center of thread as the current tool position. (Optional)
<b>YCenter</b>	Absolute Y coordinate of the center of the thread. If no coordinate is entered, the CNC puts the center of the thread as the current tool position. (Optional)
<b>ZFinish</b>	Absolute Z position where the thread cut will finish. This can be above or below the start position depending on the direction of the thread cut, up or down. (Required)
<b>ZStart</b>	Absolute Z position where the thread cut starts. This can be above or below the finish position depending on the direction of the thread cut, up or down. If not set, the cycle will use the current Z tool position. (Optional)
<b>ZSafePosn</b>	An Absolute safe Z position above the part for rapid moves in X and/or Y. (Required)
	<b>WARNING: ZSafePosn</b> must be above the part to avoid a crash while positioning.
<b>MajorDia</b>	Major thread diameter. For a tapered thread, it will be the major diameter at the Z start position. If you have a tapered hole and you start at the top and cut down, you would have a different major diameter than if you started at the bottom and cut up. (Required)  + Value cuts in the CW direction - Value cuts in the CCW direction
<b>ThdDepth</b>	Depth of thread. The incremental depth of thread on one side: (Required)  + Value is inside thread - Value is outside thread
<b>TPIorLead</b>	Threads per inch (TPI) or lead of thread. (Required)

**NOTE:** The minimum number of threads per inch is "1"

**ArclnRad** Size of radius arcing into start of thread.  
(Optional)

**NOTE:** If **ArclnRad** is a positive value or not set and the thread is “inside,” the cycle will always return to the center between passes.

If **ArclnRad** is a negative value, the cutter will move to the start or end point that is closest to the center if inside thread, and farthest away from center if outside thread.

If **ArclnRad** is not specified and the thread is “outside,” the cutter will back away from the largest diameter by an amount equal to the thread depth.

**StockAmt** Amount to leave for a finish pass after the roughing passes. (Optional)

**Passes** Number of roughing cuts to be taken.  
(Optional)

**NOTE:** If **StockAmt** is not set or set to zero and **Passes** is 1 or 0, the cycle will make just one pass at the full depth..

If **StockAmt** is set to greater than zero and **Passes** is 1 or 0, the cycle will make just one pass at the stock depth and one pass at full thread depth.

If **Passes** is set to a negative number, all non-cutting positioning moves will be rapid.

**RoughFeed** Feedrate for roughing. (If not set, the cycle will use the current active feedrate.)  
(Optional)

**FinFeed** Feedrate for the finish pass. (If not set, the cycle will use the current active feedrate.)  
(Optional)

**TaperAng** Angle on one side of the thread (not the included angle). The angle is measured from the right side going counter clockwise with a positive number and clockwise with a negative number. A straight pipe tape with an inside cut would be -1.7833. If not set, then the thread is straight. (Optional)

If X and Y are not programmed, position tool center of the thread before calling the “Thread Mill” cycle:

- X and Y will rapid to the starting position of the thread.
- Z will rapid to the safe height specified in **ZSafePosn**.

- The Z axis will feed down to the start cut position **ZStart**. This could be above or below the Z position specified in the **ZFinish** position.
- Depending on what is in the **ArclnRad** parameter, the tool will arc into the first cut position.
- Spiral up or down, depending on the difference between **ZFinish** and **ZStart** and go counterclockwise or clockwise depending if **MajorDia** is plus or minus.
- Then arc-out and feed to the thread center for inside threads, or a safe distance away from the thread for outside threads depending on the value in **ArclnRad**.
- Then feed back to the **ZStart** height.
- Then feed X and Y to the next depth of cut. The depth of each roughing pass will be the thread depth specified in the **ThdDepth** parameter minus the stock amount specified in the **StockAmt** parameter, divided by the number of roughing passes specified in the **Passes** parameter.
- The cycle repeats this process until the final finish pass.
- It will then cut the thread at the full thread major diameter.

When cutting a tapered on an inside thread, care should be taken. An error will be generated if the diameter on the small end of the taper becomes too small for the tool to fit along with arc in and out moves. Not entering an arc-in value in the **ArclnRad** parameter will allow the cycle to move to the center of the hole for maximum clearance.

## Sample Thread Program

This program will cut an 8 TPI thread starting at 0.1 above the hole. The major diameter of the thread is 1 inch. It will take 2 roughing cuts and 1 finish cut with a 0.625 cutter.

```
Dim Abs
Tool# 1
Rapid      X 1.0000 Y 1.0000
Rapid      Z 0.1000
ThreadMill Finish -1.0  ZStart 0.1  ZSafePosn .5  MajorDia
           1.0  ThdDepth .0625  TPIorLead 8  ArcInRad
           0.1  StockAmt 0.002  Passes 2  RoughFeed
           20.0  FinFeed 5.0
Rapid      Z 5.0000
EndMain
```

The tool will spiral down the thread pitch of 8 threads per inch, finishing at a depth of -1. The starting height is 0.1, the safe rapid Z height is 0.5, the major thread diameter is 1 inch, and depth of thread is 0.0625. The arc-in radius is 0.1 and the stock amount for the finish pass is 0.002. The rough feedrate is 20.0 and the finish feedrate is 5.0.

**NOTE:** If you would like all non-cutting positioning moves to be rapid, set **Passes** to a negative number. The idea is to initially set **Passes** as a positive number and after proving out the program, change it to a negative number for faster production. If you only need one pass to size and you want the positioning moves to be rapid, set **Passes** to -1.

## Pocketing Canned Cycles

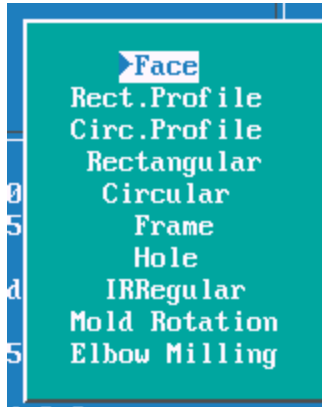

**Note**

The pockets marked with \* all have cutter compensation built into them, so all dimension are as show on print.

- |                         |   |
|-------------------------|---|
| 1.Face.                 | Cleans large area with one line of information.       |
| 2.Rectangular profile.* | Cleans inside or outside of a rectangle.              |
| 3.Circular profile.*    | Clean inside or outside of a circle.                  |
| 4.Rectangular pocket.*  | Cuts a rectangular pocket to a specified depth.       |
| 5.Circular pocket.*     | Cuts a circular pocket to specified depth.            |
| 6.Frame pocket.*        | Cuts rectangular pocket with an island in the middle. |
| 7.Hole.*                | Opens up existing holes.                              |
| 8.Irregular pocket.*    | Cleans the inside of a closed contour.                |
| 9.Mold rotation.        | Cuts three axis shape but only program 2 axis.        |
| 10.Elbow milling        | Cuts a radial groove around a radius.                 |

### Face Pocket

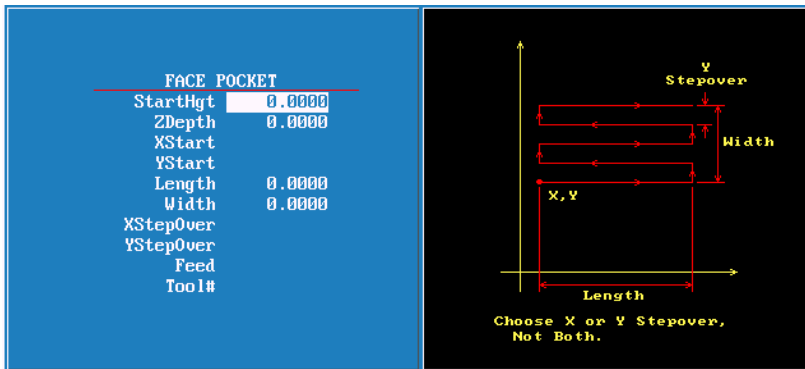

- |                   |  |                                      |
|-------------------|--|--------------------------------------|
| <b>StartHgt.</b>  | Distance above surface to be cut.          |                                      |
| <b>ZDepth.</b>    | Depth of Z axis.                           |                                      |
| <b>XStart.</b>    | X axis start position.                     | Optional                             |
| <b>YStart.</b>    | Y axis start position.                     | Optional                             |
| <b>Length.</b>    | Length of surface to be cut.               |                                      |
| <b>Width.</b>     | Width of surface to be cut.                |                                      |
| <b>XStepOver.</b> | Distance X axis steps over between passes. | Only one step over to be programmed. |
| <b>YStepOver.</b> | Distance Y axis steps over between passes. | Only one step over to be programmed. |
| <b>Feed.</b>      | Feedrate in inches per minute.             | Optional                             |
| <b>Tool#.</b>     | Tool number.                               | Optional                             |

Only input with 0.0000 have to be programmed , this will apply to all canned cycles.Tools do not have to be programmed in cycles , in most cases it is not a good idea.



**Rectangular profile**

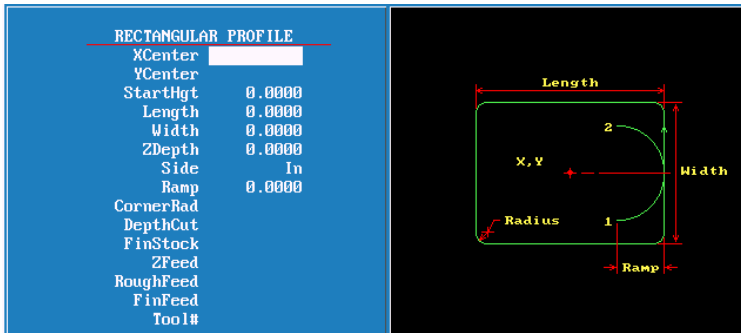

<b>XCenter.</b>	Center of profile along X axis.	Optional
<b>YCenter.</b>	Center of profile along Y axis	Optional
<b>StartHgt.</b>	Height Above surface to be cut.	
<b>Length.</b>	Length of pocket.	
<b>Width.</b>	Width of pocket.	
<b>ZDepth.</b>	Absolute depth of pocket.	
<b>Side.</b>	Inside or Outside.	
<b>Ramp.</b>	Size of ramp radius.	
<b>CornerRad.</b>	Radius on the corners. On the inside must be larger than cutter radius.	Optional
<b>DepthCut.</b>	How deep per pass.	Optional
<b>FinStock.</b>	Material left for finish pass.	Optional
<b>ZFeed.</b>	Z axis down feed.	Optional
<b>RoughFeed.</b>	Feedrate used for roughing passes.	Optional
<b>FinFeed.</b>	Feedrate for finish pass.	Optional
<b>Tool#.</b>	Tool to be used.	Optional

**Circular profile**

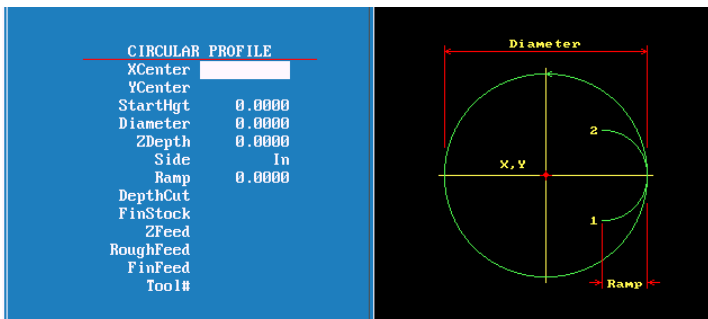

<b>XCenter.</b>	Center of profile along X axis.	Optional
<b>Ycenter.</b>	Center of profile along Y axis	Optional
<b>StartHgt.</b>	Height Above surface to be cut.	
<b>Diameter.</b>	Diameter of pocket.	
<b>ZDepth.</b>	Absolute depth of pocket.	
<b>Side.</b>	Inside or Outside.	
<b>Ramp.</b>	Size of ramp radius.	
<b>DepthCut.</b>	How deep per pass.	Optional
<b>FinStock.</b>	Material left for finish pass.	Optional
<b>Zfeed.</b>	Z axis down feed.	Optional
<b>RoughFeed.</b>	Feedrate used for roughing passes.	Optional
<b>FinFeed.</b>	Feedrate for finish pass.	Optional
<b>Tool#.</b>	Tool to be used.	Optional

**Rectangular Pocket**

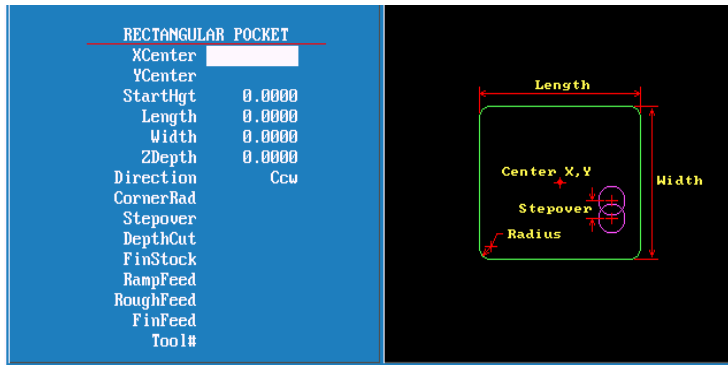

<b>Xcenter.</b>	Center of pocket X axis.	Optional
<b>Ycenter.</b>	Center of pocket Y axis.	Optional
<b>StartHgt.</b>	Must be .1" or 2mm above surface to be cut.	
<b>Length.</b>	Actual length of pocket.	
<b>Width.</b>	Actual width of pocket.	
<b>Zdepth.</b>	Absolute distance to bottom of pocket.	
<b>Direction.</b>	Defaulted to climb mill.	
<b>CornerRad.</b>	Radius in corners must be larger than cutter radius.	Optional
<b>StepOver.</b>	Step over between passes , cannot exceed 70% of cutter diameter.	Optional
<b>DepthCut.</b>	Depth of Z per pass.	Optional
<b>FinStock.</b>	Amount of material left for finish cut , material left on side and bottom.	Optional
<b>RampFeed.</b>	Feedrate for initial # axis move.	Optional
<b>RoughFeed.</b>	Rough feedrate.	Optional
<b>FinFeed.</b>	Finish feedrate.	Optional
<b>Tool #.</b>	Tool number normally not input here.	Optional

**Circular Pocket**

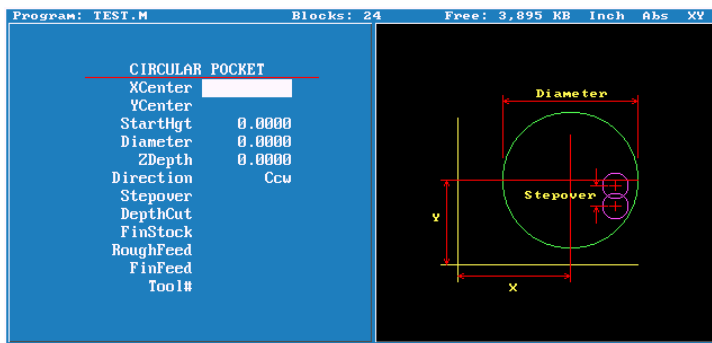

<b>Xcenter.</b>	Center of pocket X axis.	Optional
<b>Ycenter.</b>	Center of pocket Y axis.	Optional
<b>StartHgt.</b>	Must be .1" or 2mm above surface to be cut.	
<b>Diameter.</b>	Actual diameter of pocket.	
<b>Zdepth.</b>	Absolute distance to bottom of pocket.	
<b>Direction.</b>	Defaulted to climb mill.	
<b>StepOver.</b>	Step over between passes , cannot exceed 70% of cutter diameter.	Optional
<b>DepthCut.</b>	Depth of Z per pass.	Optional
<b>FinStock.</b>	Amount of material left for finish cut , material left on side and bottom.	Optional
<b>RoughFeed.</b>	Rough feedrate.	Optional
<b>FinFeed.</b>	Finish feedrate.	Optional
<b>Tool #.</b>	Tool number normally not input here.	Optional

**Frame Pocket**

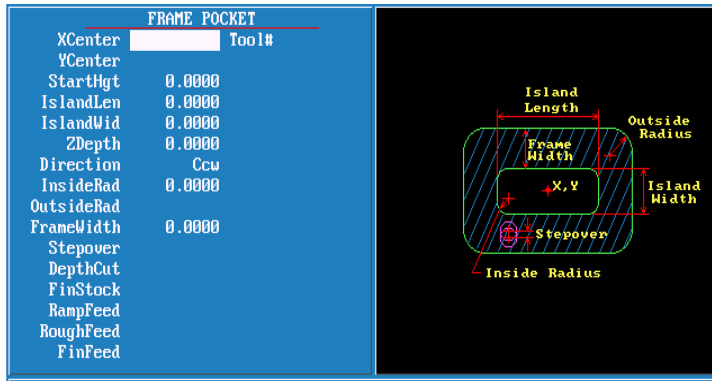

<b>Xcenter</b>	Center of pocket X axis.	Optional
<b>Ycenter</b>	Center of pocket Y axis.	Optional
<b>StartHgt</b>	Must be .1" or 2mm above surface to be cut.	
<b>IslandLen</b>	Actual length of center island.	
<b>IslandWid</b>	Actual width of center island.	
<b>Zdepth</b>	Absolute distance to bottom of pocket.	
<b>Direction</b>	Defaulted to climb mill.	
<b>InsideRad</b>	Radius in corners must be larger than cutter radius.	
<b>OutsideRad</b>	Radius outside corners , must be larger than radius of cutter.	Optional
<b>FrameWidth</b>	Distance from island to outside.	
<b>StepOver</b>	Step over between passes , cannot exceed 70% of cutter diameter.	Optional
<b>DepthCut</b>	Depth of Z per pass.	Optional
<b>FinStock</b>	Amount of material left for finish cut , material left on side and bottom.	Optional
<b>RampFeed</b>	Feedrate for initial # axis move.	Optional
<b>RoughFeed</b>	Rough feedrate.	Optional
<b>FinFeed</b>	Finish feedrate.	Optional
<b>Tool #</b>	Tool number normally not input here.	Optional

**Hole-Mill Pocket**

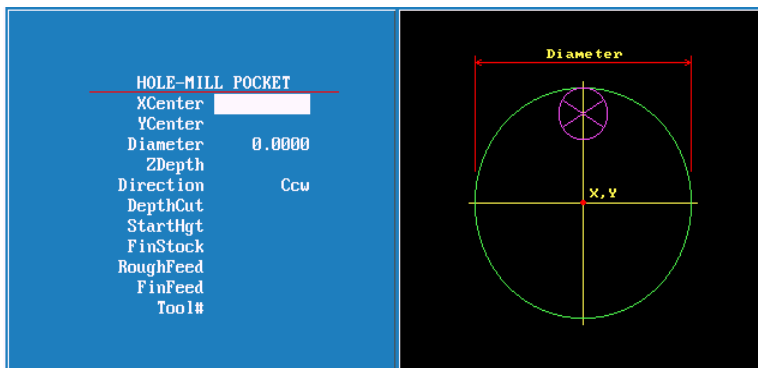

<b>Xcenter</b>	Center of pocket X axis.	Optional
<b>Ycenter</b>	Center of pocket Y axis.	Optional
<b>Diameter</b>	Actual diameter of pocket.	
<b>Zdepth</b>	Absolute distance to bottom of pocket.	Optional
<b>Direction</b>	Defaulted to climb mill.	
<b>DepthCut</b>	Depth of Z per pass.	Optional
<b>StartHgt</b>	Start height above surface to be cut.	Optional
<b>FinStock</b>	Amount of material left for finish cut , material left on side and bottom.	Optional
<b>RoughFeed</b>	Rough feedrate.	Optional
<b>FinFeed</b>	Finish feedrate.	Optional
<b>Tool #</b>	Tool number normally not input here.	Optional

**Irregular Pocket**

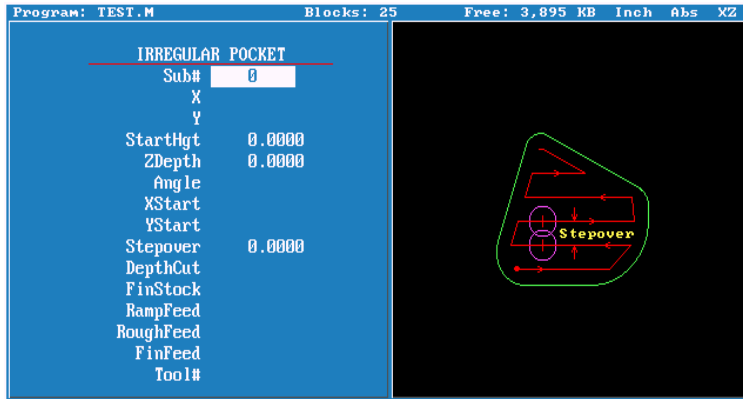

<b>Sub#</b>	# of profile subroutine.	
<b>X</b>	Start position of profile X axis.	Optional
<b>Y</b>	Start position of profile Y axis.	Optional
<b>StartHgt</b>	Start height .1" or 2mm above surface to be cut.	
<b>Zdepth</b>	Z depth of pocket absolute.	
<b>Angle</b>	Angle of first cut.	Optional
<b>Xstart</b>	Position of X axis before moving to start of profile.	Optional
<b>Ystart</b>	Position of Y axis before moving to start of profile.	Optional
<b>Stepover</b>	Distance cut will move over between passes.	
<b>DepthCut</b>	Depth of cut per pass.	Optional
<b>FinStock</b>	Amount of material left for finish pass. Leave stock on side and bottom of pocket.	Optional
<b>RampFeed</b>	Feedrate into material. Normally Z axis into material.	Optional
<b>RoughFeed</b>	Feedrate for roughing passes.	Optional
<b>FinFeed</b>	Feedrate for finish pass	Optional
<b>Tool#</b>	Tool #	Optional

**Note**

A subroutine has to be programmed for this cycle . The subroutine must start and end at the same coordinates. The first move can be a Rapid , put both X and Y axis in this block also the last block should have both X and Y axis coordinates.

Angle would normally only be used when starting point of profile is on a radius.

**Mold Rotation**

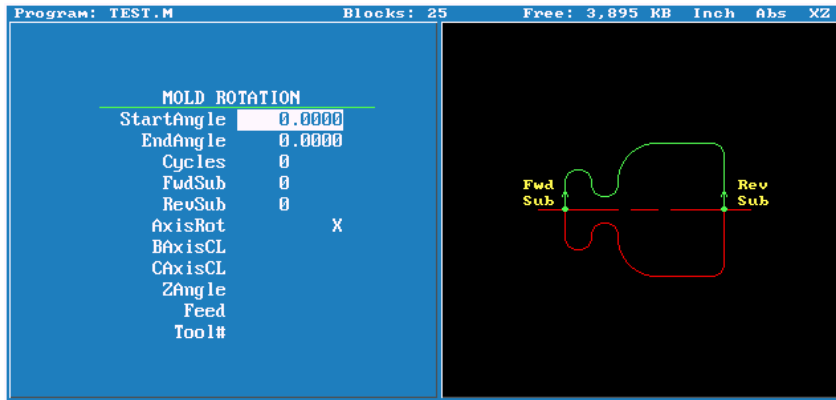

- StartAngle** Angle at which rotation is going to start.
- EndAngle** Angle at which rotation is going to end.
- Cycles** Number of passes , one cycle is a pass in each direction.
- FwdSub** Number of first subroutine.
- RevSub** Number of second subroutine.
- AxisRot** Axis around which rotation is going take place.
- BAxisCL** Position of rotated axis if not zero.
- CAxisCL** Position of second axis if not zero.
- ZAngle** If rotating X or Y rotation around Z.
- Feed** Feedrate
- Tool#** Tool # .

**Elbow Milling**

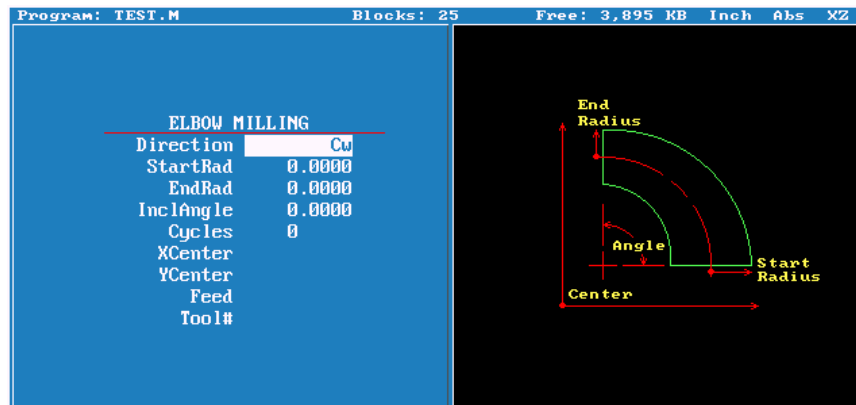

- Direction** Cut direction of first pass.
- StartRad** Radius at start end.
- EndRad** Radius at opposite end.
- InclAngle** Included angle of cavity.
- Cycles** Number of passes , one cycle equals a pass in each direction.
- XCenter** Center of arc X axis. Optional
- YCenter** Center of arc Y axis. Optional
- Feed** Feedrate. Optional
- Tool#** Tool #. Optional

## Pockets with Islands

This cycle allows islands in irregular pockets. The main pocket must be the lowest subroutine number. Normally, this would be one (1). Pockets with Islands can be programmed using:

- DXF (see "Section 15, Using DXF for Pockets with Islands (G162)")
- Subroutines

More than one Island cycle can be programmed at a time. They may be strung together, but on separate lines. Islands can be programmed inside of islands. Five islands can be put on a line. The shape number subroutine number is used as inputs.

### Using Subroutines for Pockets with Islands

This example using subroutines for Pockets with Islands uses the following illustration. See **Figure 5-24** and **Table 5-1 Pockets with Islands Subroutines Programming Example**.

The numbers are the subroutine numbers.

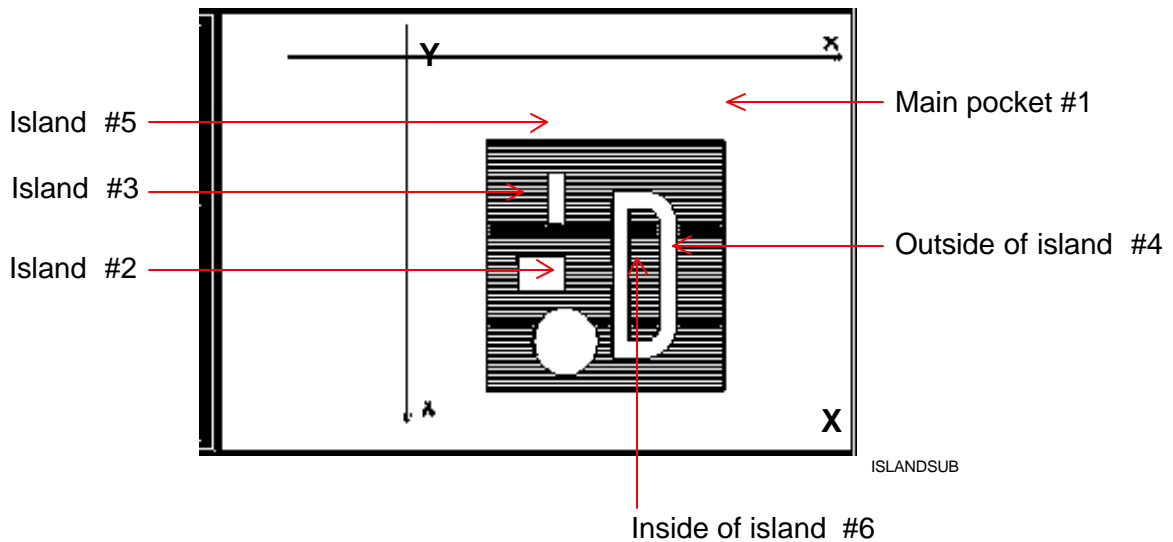

**Figure 5-24, Subroutines Pockets with Islands Example Workpiece**

In **Table 5-1** Island # 4 (FourthIsl) has a – (minus) in front of it, this is because the comp needs to be on the inside, as it is a pocket inside of an island.

**Table 5-1 Pockets with Islands Subroutines Programming Example**

```
Unit Inch
Dim Abs
Tool# 0
Rapid      X 0.0000 Y 0.0000 Z 0.0000 Feed 50.0000
Islands    FirstIsl 4.0000 SecondIsl 3.0000 ThirdIsl 2.0000
FourthIsl -6.0000 FifthIsl 5.0000
Pocket     Sub# 1.0000 StartHgt 0.2000 ZDepth -0.9000
Stepover 0.1900 DepthCut 0.2500 RoughFeed 50.0000 FinStock
0.0100 FinFeed 50.0000
RampFeed 50.0000 Tool# 1.0000
MCode 5 Z 5.0000
EndMain
Sub 1
Rapid      X 5.0000 Y 5.0000 Feed 50.0000
Line      X 20.0000
Line      Y 20.0000
Line      X 5.0000
Line      Y 5.0000
EndSub
Sub 2
Rapid      X 9.0000 Y 7.0000 Feed 50.0000
Line      X 10.0000
Line      Y 10.0000
Line      X 9.0000
Line      Y 7.0000
EndSub
Sub 3
Rapid      X 7.0000 Y 12.0000 Feed 50.0000
Line      X 10.0000
Line      Y 14.0000
Line      X 7.0000
Line      Y 12.0000
EndSub
Sub 4
Rapid      X 13.0000 Y 8.0000 Feed 50.0000
Line      X 15.0000
Arc Ccw   X 17.0000 Y 10.0000 Radius 2.0000
Line      Y 16.0000
Arc Ccw   X 15.0000 Y 18.0000 Radius 2.0000
```

```
Line      X 13.0000
Line      Y 8.0000
EndSub
Sub 5
Rapid     X 8.0000 Y 17.0000 Feed 50.0000
Arc Ccw   X 12.0000 Y 17.0000 Radius 2.0000
Arc Ccw   X 8.0000 Y 17.0000 Radius 2.0000
EndSub
Sub 6
Rapid     X 14.0000 Y 9.0000
Line      X 15.0000
Arc Ccw   X 16.0000 Y 10.0000 Radius 1.0000
Line      Y 16.0000
Arc Ccw   X 15.0000 Y 17.0000 Radius 1.0000
Line      X 14.0000
Line      Y 9.0000
EndSub
```





There are two more canned cycles , to get to these press

**F5**

**Mill**

soft key.



Soft key will change as above press

**F7**

**More**

a pop-up will appear as below.

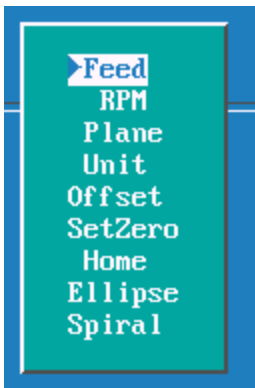

Ellipse and spiral both must be programmed incrementally .

Put height light on Ellipse press

**E  
N  
T  
E  
R**

screen will change as below.

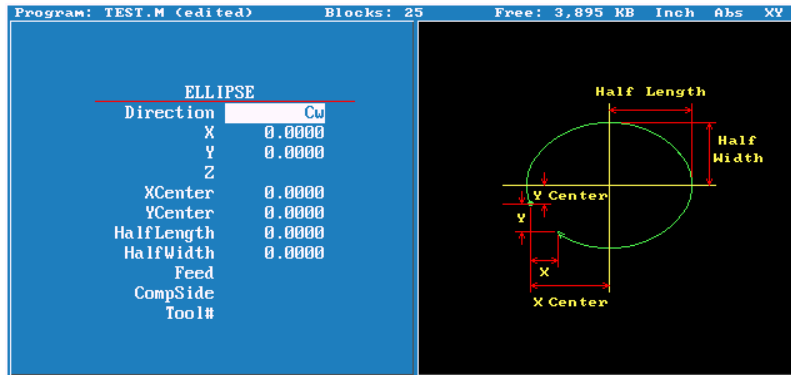

- Direction** Direction of cut CW or CCW.
- X** Distance from Start to End X axis of Ellipse.
- Y** Distance from Start to End Y axis of Ellipse.
- Z** Distance from Start to End Z axis of Ellipse.
- Xcenter** Distance from Start to Center X axis of Ellipse.
- Ycenter** Distance from Start to Center Y axis of Ellipse.
- HalfLength** Half the length of Ellipse X axis.
- HalfWidth** Half the width of Ellipse Y axis.
- Feed** Feedrate.
- CompSide** Tool compensation none , inside or outside.
- Tool#** Tool number.

If plane is changed to XZ plane Ycenter would change to ZCenter and half width is Z axis .  
 If plane is changed to YZ plane Xcenter would change to YCenter and half length would be Y axis .  
 Using in side or outside tool compensation the the cutter must be placed in the correct compensated position , before programming Ellipse. All dimension **MUST** be Incremental when programming this cycle.

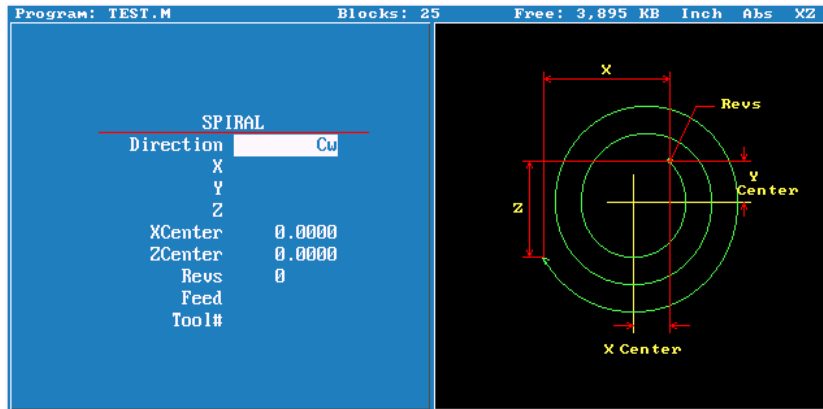

<b>Direction</b>	Direction of Spiral Clockwise or Counter Clockwise.
<b>X</b>	Distance from Start to End X axis .
<b>Y</b>	Distance from Start to End Y axis .
<b>Z</b>	Distance from Start to End Z axis.
<b>Xcenter</b>	Distance from Start to Center X.
<b>Ycenter</b>	Distance from Start to Center Y.
<b>Revs</b>	Number of Revolutions.
<b>Feed</b>	Feedrate.
<b>Tool#</b>	Tool number.

This can be programmed in XY , XZ or YZ planes , the center designations with change accord selected plane .

All dimension **MUST** be Incremental when programming this cycle

Cutter compensation no allowed with this cycle.

If cutting a thread using this cycle the distance moved in Z into number of revolutions will equal lead of thread .

## Engraving, Repeat, and Mill Cycles

This section describes operation of three new cycles:

- Engraving Cycle
- Repeat Cycle
- Mill Cycle

### Engraving Cycle

The Engraving cycle provides a quick and easy way to engrave part numbers, legends, or any alpha/numeric inscription. The usual type of cutter is a sharp point or center-drill type tool. Options are given for engraving on an angle and mirror is supported for engraving molds. When executed, the CNC rapids to the start point, then to the StartHgt. It then feeds to the Zdepth specified and begins cutting the Text selected.

### Programming the Engraving Cycle

To program the Engraving Cycle:

1. In Edit mode, press **Mill (F5)** and **More (F7)** to display the More pop-up menu, **Figure 5-48**. Highlight **Engrave** and press **ENTER** to display the Engraving Cycle screen, **Figure 5-49, Engraving Cycle Screen**.
2. Complete the entry fields (refer to **Table 5-2, Engraving Cycle Entry Fields**), and press **ENTER**.

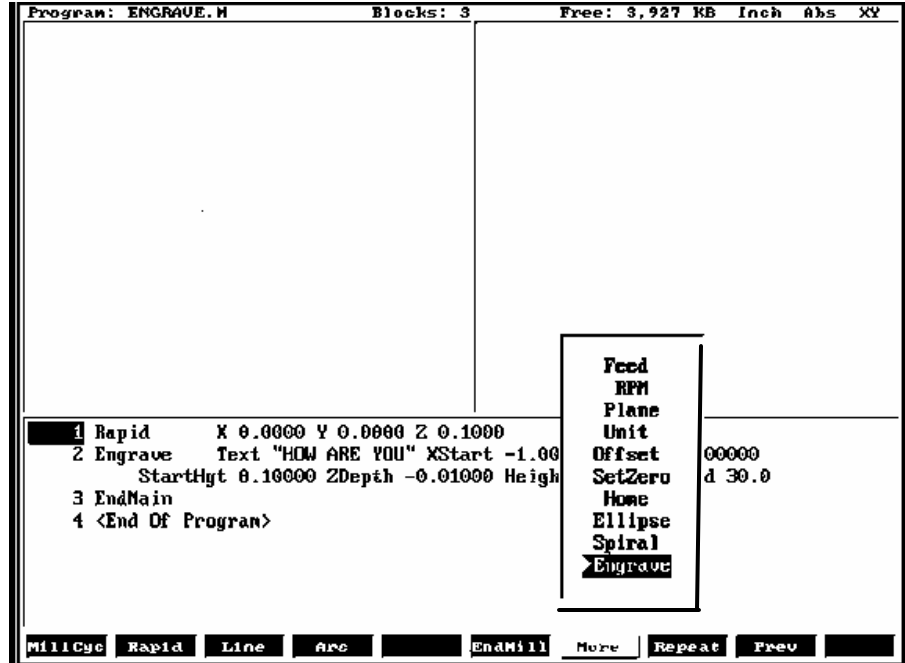

Figure 5-48, More Pop-up Menu

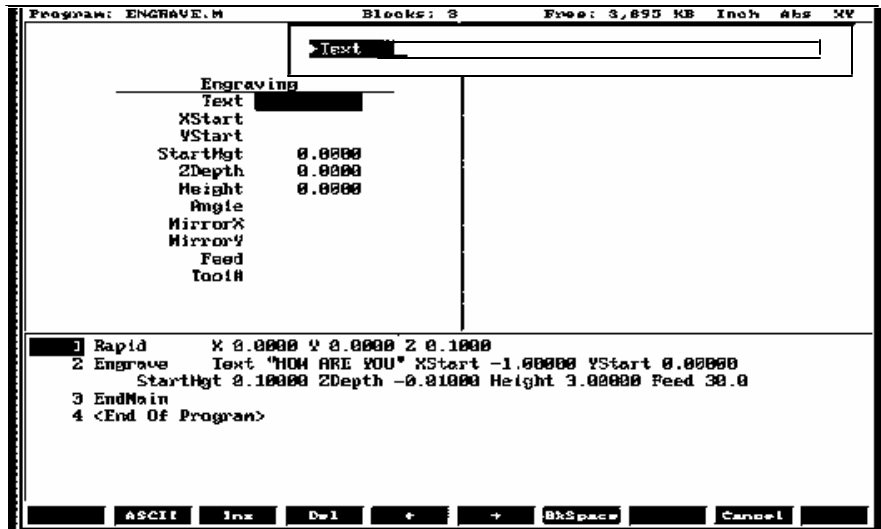

Figure 5-49, Engraving Cycle Screen

Table 5-2, Engraving Cycle Entry Fields

Entry Fields	Description
Text	When the cursor is on Text, it displays an entry field for the letters to be engraved. Letters A – Z, numbers 0 – 9, and: space, ampersand, plus, minus, comma, period, and slash right are supported. No lower case letters are allowed. If you have no external keyboard, use the ASCII Chart to enter text (see <b>Figure 2-4, ASCII Chart Pop-up</b> ). Press ENTER to accept the text. [Required]
XStart	X coordinate for lower-left corner of the text. Defaults to current position if not given. [Optional]
YStart	Y coordinate for lower-left corner of the text. Defaults to current position if not given. [Optional]
StartHgt	Z absolute start height. Must be higher than Zdepth. [Required]
Zdepth	Z absolute depth of engraving. Must be below StartHgt. [Required]
Height	Letter height. Width will be proportional to height. Height is measured at the centerline of the cutter. [Required]
Angle	Angle in degrees. Default is 0 degrees. [Optional]
MirrorX	Mirrors all X moves. Set by using minus key (-) while in this field. [Optional]
MirrorY	Mirrors all Y moves. Set by using minus key (-) while in this field. [Optional]
Feed	Feedrate used while engraving. Default is current feedrate. [Optional]
Tool#	Active Tool [Optional] Used only on 3000M controls – not on 6000M

Text

Engraving

A	B	C	D	E	F	G	H	I	J	K	7	8	9
L	M	N	O	P	Q	R	S	T	U		4	5	6
V	W	X	Y	Z							1	2	3
&											-	0	.
											+		/

1 <End Of Program>

## Sample Engraving Cycle Program

```
1 Dim Abs
2 Unit Inch
3 Rapid X 0.00000 Y 0.00000
4 Tool# 1
5 Rapid X 1.00000 Y 1.00000
6 Rapid Z 0.10000
7 Engrave Text "ABCD" StartHgt 0.0100 ZDepth -0.0100 Height 0.5000
8 Rapid Z 1.00000
9 Rapid X 0.00000 Y 0.00000
10 EndMain
```

This program will rapid to X1.0 Y1.0. Z will rapid to 0.1 and the letters ABCD will be engraved 0.0100" deep and 0.500" high.

## Repeat Cycle

The Repeat cycle allows a series of previously programmed blocks to be repeated. Some examples are going over the same contour while lowering the Z-axis, or drilling over a series of holes with a different drill cycle, or moving an operation to a different location using fixture offsets. Wherever it is used, the repeated blocks will be processed, just as if they were written in the program at that point.

## Programming the Repeat Cycle

To program the Repeat Cycle:

1. In Edit mode, press **Mill (F5)** and **Repeat (F8)** to display the Repeat Cycle screen, **Figure 5-50**.

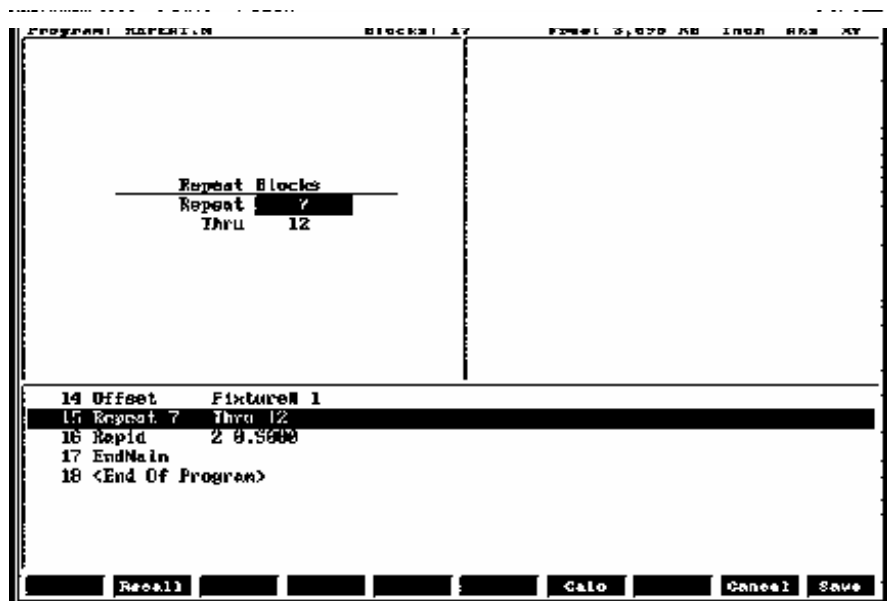

Figure 5-50, Repeat Cycle Screen

- Complete the entry fields (refer to **Table 5-3**), and press **ENTER**.

**Table 5-3, Repeat Cycle Entry Fields**

Entry Field	Description
Repeat	Type the block number you want to begin repeating. [Required]
Thru	Type the block number you want to end the repeat. [Required]

- When using a Modal Drilling Cycle with the Repeat feature, a **DrillOff** or non-move command must be included as the final block. For example, see “Sample Repeat Cycle Program” block 7–12 and block 15.

**Sample Repeat Cycle Program**

```

1   Dim Abs
2   Unit Inch
3   Offset  Fixture# 0
4   Rapid  X 0.0000 Y 0.0000
5   Tool# 1
6   Rapid  Z 0.1000
7   BasicDrill ZDepth -0.50000 StartHgt 0.10000 Feed 15.0
8   Rapid  X 1.00000
9           Y 1.0000
10          X 0.0000
11          Y 0.0000
12  DrillOff
13  Offset  Fixture# 1 X 3.0000 Y 0.0000
14  Offset  Fixture# 1
15  Repeat 7 Thru 12
16  Rapid  Z 0.5000
17  EndMain

```

This program will drill four holes. A Fixture Offset is used to relocate X Y zero. When the Repeat Cycle is encountered, it will drill four more holes at the offset location.



## Mill Cycle

The Mill cycle is intended for contour milling operations. Cutter compensation, Z pecking, Z finish stock, RoughFeed, and FinishFeed are supported. The cycle will rapid to the XY start point (compensated, if comp is on) rapid to the start height and then feed to the Zdepth or DepthCut using the Zfeed. Subsequent milling blocks are then executed using the ToolComp parameter and Feed specified. The feedrate can be changed in the blocks that are being milled, but not Cutter Comp. The cycle is terminated with the EndMill block at which point it rapids up to the StartHgt and returns to the un-comped XStart YStart location.

### Programming the Mill Cycle

To program the Mill Cycle:

1. In Edit mode, press **Mill (F5)** and **MillCyc (F1)** to display the Mill Cycle screen, **Figure 5-51**.
2. Complete the entry fields (refer to **Table 5-4, Mill Cycle Entry Fields**), and press ENTER.

### Programming the EndMill Block

To program the EndMill Block:

1. In Edit mode, press **EndMill (F6)** to end the cycle.

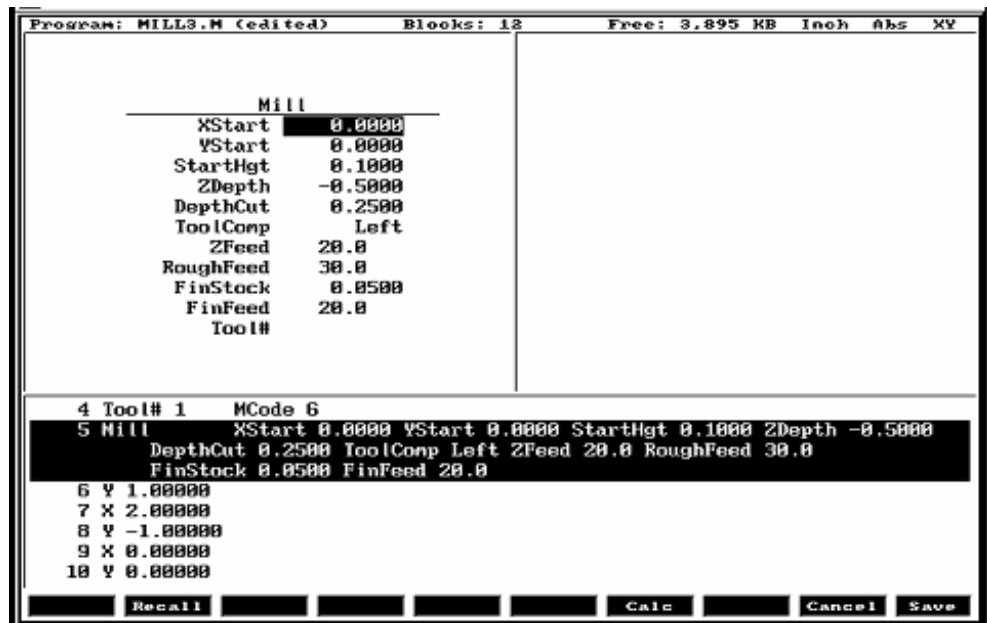

Figure 5-51, Mill Cycle Screen

**Table 5-4, Mill Cycle Entry Fields**

Entry Field	Description
XStart	X coordinate for start of Mill cycle. Defaults to current position if not given. [Optional]
YStart	Y coordinate for start of Mill cycle. Defaults to current position if not given. [Optional]
StartHgt	Z absolute start height. Must be 0.100" above work surface (0.2mm). [Required]
ZDepth	Absolute depth of finished contour. [Required]
DepthCut	Depth of cut taken in a single pass. Cuts will be adjusted so that all are equal pecks. [Optional]
ToolComp	Tool radius compensation Left or Right of programmed path. Set by using minus key (-) while in this field. [Optional]
ZFeed	Feedrate for Z-axis. Defaults to current feedrate. [Optional]
RoughFeed	Feedrate for X and Y-axis. Defaults to current feedrate. [Optional]
FinStock	Amount of stock to take for last Z peck. [Optional]
FinFeed	Feedrate used for FinStock. [Optional]
Tool #	Active Tool. [Optional] Used only on 3000M controls – not on 6000M

**Sample Mill Cycle Program**

```

1   Dim Abs
2   Unit Inch
3   Rapid   X 0.00000 Y 0.00000
4   Tool# 1   MCode 6
5   Mill     XStart 0.00000 YStart 0.00000 StartHgt 0.10000
        ZDepth -0.50000 DepthCut 0.25000 ToolComp Left ZFeed 20.0
        Feed 30.0
6   Y 1.00000
7   X 2.00000
8   Y -1.00000
9   X 0.00000
10  Y 0.00000
11  EndMill
12  EndMain

```

This program will contour a square, in two Z pecks of 0.250" each. The blocks 6 thru 10 are the contour moves that will be compensated to the left of tool path direction. Block 11, EndMill is required to show the end of the contour. The cutter will be returned to the start point, X0 Y0 at the start height of 0.100".

# ANILAM

## 3000M Rotate / Mirror / Scale

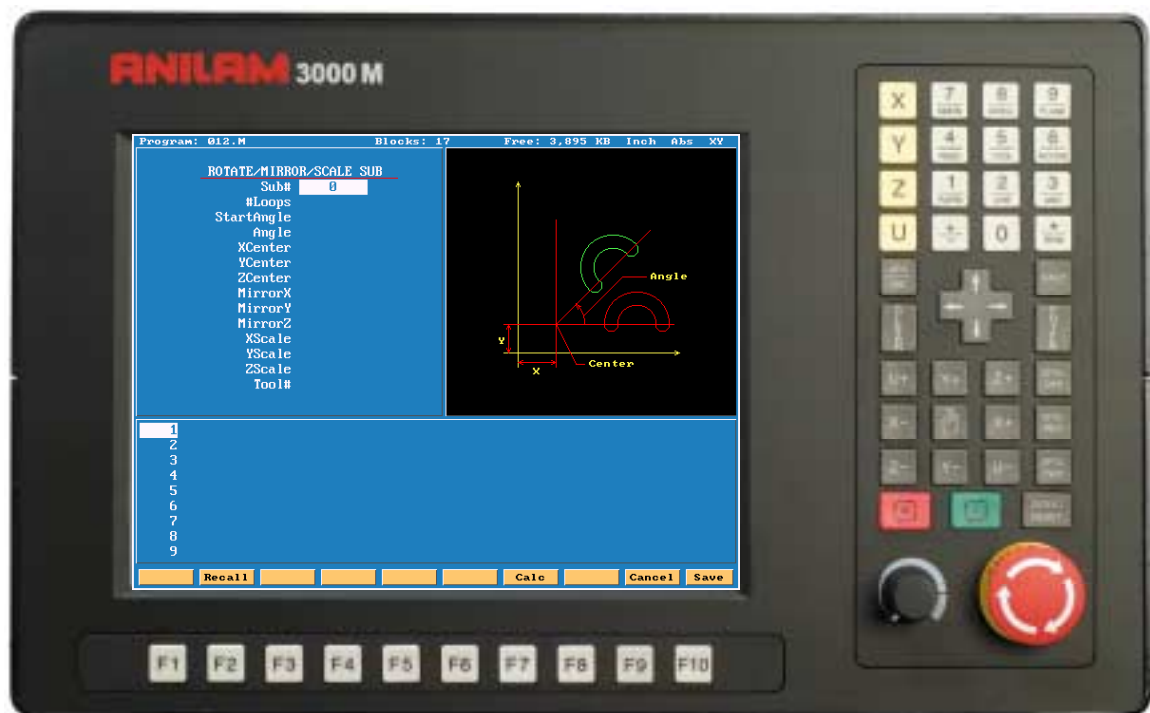

To get to RMS , when in edit press



Press

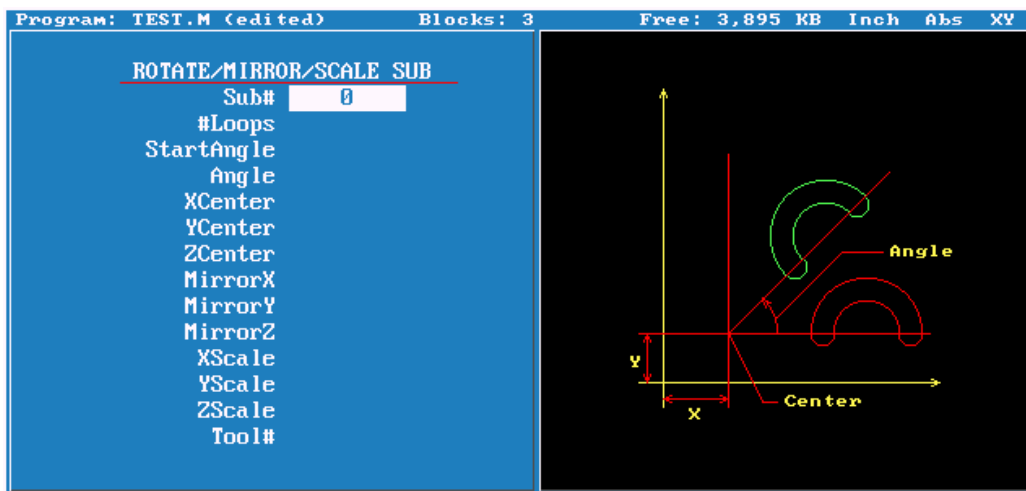

- Sub#** Number of subroutine to Rotated, Mirrored or Scaled
- #Loops** Number of time to repeat Rotation.
- StartAngle** Start angle of rotation.
- Angle** Angle between Rotations.
- Xcenter** Center of Rotation X axis.
- Ycenter** Center of Rotation Y axis.
- Zcenter** Center of Rotation Z axis.
- MirrorX** Mirror X axis.
- MirrorY** Mirror Y axis.
- MirrorZ** Mirroe z axis.
- Xscale** Scale X axis.
- Yscale** Scale Y axis.
- Zscale** Scale Z axis.
- Tool#** Tool number.

## Rotation

When using RMS a subroutine must be written.

```

Program: TEST.M (edited)      Blocks:
-----
  ROTATE/MIRROR/SCALE SUB
    Sub#      1
    #Loops    4
    StartAngle 0.0000
    Angle     90.0000
    XCenter   3.0000
    YCenter   3.0000
  
```

Above are the entries in canned cycle.

Press **F10** **Save**

```

1 Dim Abs
2 Rapid      Z 0.0000 Tool# 0
3 Tool# 1
4 RMS        Sub# 1 #Loops 8 StartAngle 0.0000 Angle 45.0000
           XCenter 3.0000 YCenter 3.0000
5 Rapid      Z 0.0000 Tool# 0
6 EndMain
7 Sub 1
8 Rapid      X 4.0000 Y 3.0000
9 Rapid      Z 0.1000
10 Line      Z -0.1000 Feed 5.0
11 Line      X 5.0000 Feed 10.0
12 Line      Z 0.1000
13 EndSub
  
```

This how the program will look, line #4 is the rotation cycle.  
 Note all moves including Z's are in the subroutine.

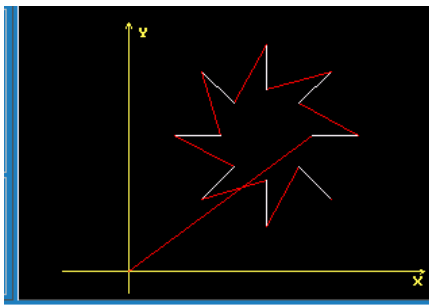

This is how it look in graphics.

In the case only one rotation is required the entry would be as below.  
Note only 4 entries Sub , StartAngle , X & Y centers.

<u>ROTATE/MIRROR/SCALE SUB</u>	
Sub#	1
#Loops	
StartAngle	45.0000
Angle	
XCenter	3.0000
YCenter	3.0000

Program line would look as below.

```
3 Tool# 1  
4 RMS Sub# 1 StartAngle 45.0000 XCenter 3.0000 YCenter 3.0000  
5 Rapid Z 0.0000 Tool# 0
```

Graphics of the single rotation appears below.

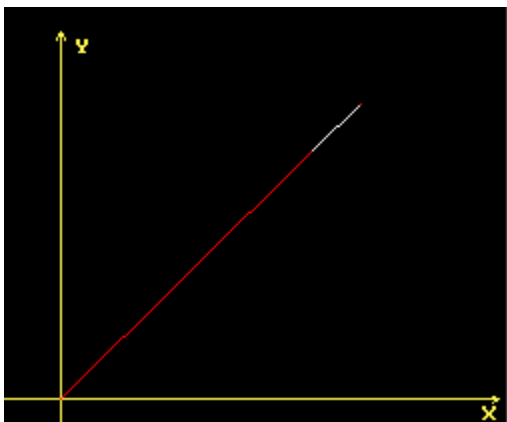

## Mirror

Mirror also requires a Subroutine to be written.

Put highlight on axis to be mirrored press +/- key to turn on.

```

ROTATE/MIRROR/SCALE SUB
-----
Sub#      1
#Loops
StartAngle
Angle
XCenter
YCenter
ZCenter
MirrorX   Yes
MirrorY   Yes
MirrorZ
    
```

Line #4 as programmed  
Line #6 mirror imaged

```

1 Dim Abs
2 Rapid      Z 0.0000 Tool# 0
3 Tool# 1
4 Call 1
5 RMS              Sub# 1 MirrorX Yes MirrorY Yes
6 Rapid      Z 0.0000 Tool# 0
7 EndMain
8 Sub 1
9 Rapid      X 1.0000 Y 1.0000
10 Rapid     Z 0.1000
11 Line      Z -0.1000 Feed 5.0
12 Line      X 3.0000 Feed 10.0
13 Line      Y 3.0000
14 Line      X 1.0000
15 Line      Y 1.0000
16 Line      Z 0.1000
17 EndSub
    
```

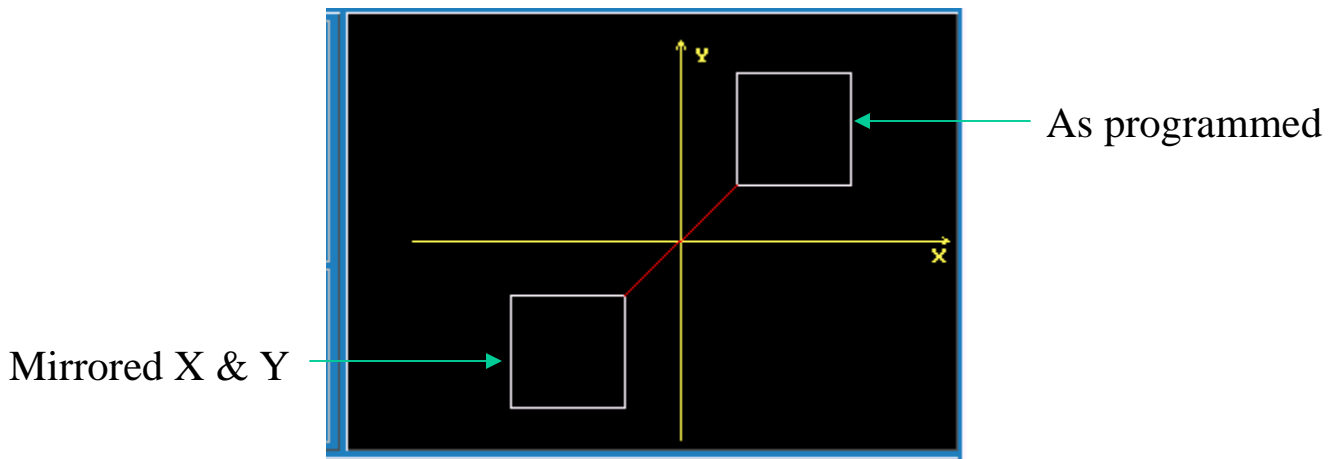

The following program shows the part cut in all four Quadrants. The one thing to keep in mind when using mirror image is that when using cutter compensation the cut direction will change in the diagonal quadrants.

```

1 Dim Abs
2 Rapid      Z 0.0000 Tool# 0
3 Tool# 1
4 Call 1
5 RMS       Sub# 1 MirrorX Yes
6 RMS       Sub# 1 MirrorX Yes MirrorY Yes
7 RMS       Sub# 1 MirrorY Yes
8 Rapid      Z 0.0000 Tool# 0
9 EndMain
10 Sub 1
11 Rapid     X 1.0000 Y 1.0000
12 Rapid     Z 0.1000
13 Line      Z -0.1000 Feed 5.0
14 Line      X 3.0000 Feed 10.0
15 Line      Y 3.0000
16 Line      X 1.0000
17 Line      Y 1.0000
18 Line      Z 0.1000
19 EndSub
    
```

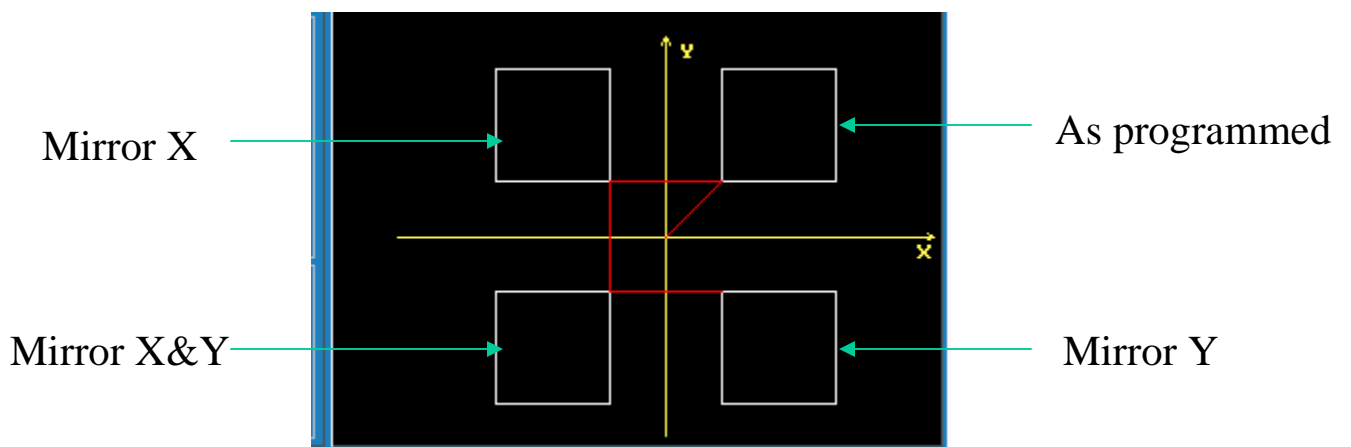



## Scale

Scale allow programmer to change the size of the part.  
One thing to remember is that if radii are involved both axis must be scale the same amount.

```
1 Dim Abs
2 Rapid      Z 0.0000 Tool# 0
3 Tool# 1
4 Rapid      X 0.0000 Y 0.0000
5 Call 1
6 Rapid      X 0.0000 Y 0.0000
7 RMS        Sub# 1 XScale 2.0000 YScale 2.0000
8 Rapid      Z 0.0000 Tool# 0
9 EndMain
10 Sub 1
11 Rapid      Z 0.1000
12 Line       Z -0.1000 Feed 5.0
13 Line       X 3.0000 Feed 10.0
14 Line       Y 3.0000
15 Line       X 0.0000
16 Line       Y 0.0000
17 Line       Z 0.1000
18 EndSub
```

Line #5 original line #6 scaled x2

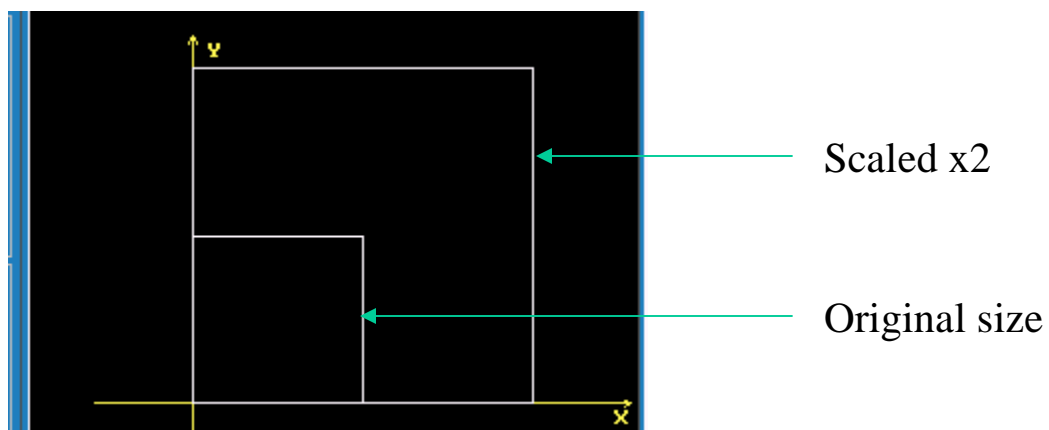

```

1 Dim Abs
2 Rapid      Z 0.0000 Tool# 0
3 Tool# 1
4 Rapid      X 0.0000 Y 0.0000
5 Call 1
6 Call 2
7 Call 3
8 Dim Abs
9 Rapid      X 0.0000 Y 0.0000
10 RMS       Sub# 100 StartAngle 20.0000 XCenter 0.0000 YCenter 0.0000
        MirrorX Yes MirrorY Yes XScale 2.0000 YScale 2.0000
11 Rapid      Z 0.0000 Tool# 0
12 EndMain
13 Sub 100
14 Call 1
15 Call 2
16 Call 3
17 EndSub
18 Sub 1      * "A"
19 Dim Abs
20 Line Z-.005
21 Dim Incr
22 X0.0739 Y0.2300
23 X0.0164
24 X0.0739 Y-0.2300
25 Dim Abs
26 Rapid
27 Z.05
28 Dim Incr
29 X-0.1432 Y0.0657
30 Dim Abs
31 Line Z-.005
32 Dim Incr
33 X0.1221
34 Dim Abs
35 Rapid 2.05
36 Dim Incr
37 X0.0211 Y-0.0657
38 X.06
39 EndSub
40
41 Sub 02    * "B"
42 Dim Abs
43 Line Z-.005
44 Dim Incr
45 Y0.2300
46 X0.0700
47 Arc Cw X0.0000 Y-0.1068 XCenter0.0000 YCenter-0.0534
48 Line X-0.0700
49 X0.0063
50 Arc Cw X0.0000 Y-0.1232 XCenter0.0000 YCenter-0.0616
51 Line X-0.0063
52 Dim Abs
53 Rapid 2.05
54 Dim Incr
55 X0.1479
56 X.06
57 EndSub
58
59 Sub 03    * "C"
60 Dim Incr
61 Rapid X0.1508 Y0.0522
62 Dim Abs
64 Dim Incr
65 Arc Cw X-0.1413 Y0.0000 XCenter-0.0707 YCenter0.0217
66 Arc Cw X0.0000 Y0.1256 XCenter0.2041 YCenter0.0628
67 Arc Cw X0.1413 Y0.0000 XCenter0.0707 YCenter-0.0217
68 Dim Abs
69 Rapid 2.05
70 Dim Incr
71 X.06 Y-0.1778
72 EndSub

```

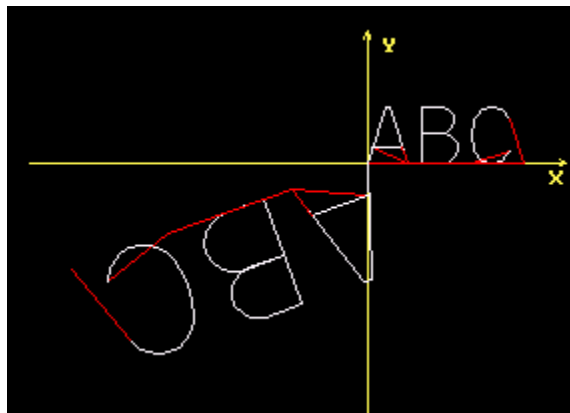

# ANILAM

## 3000M Cut / Copy / Paste

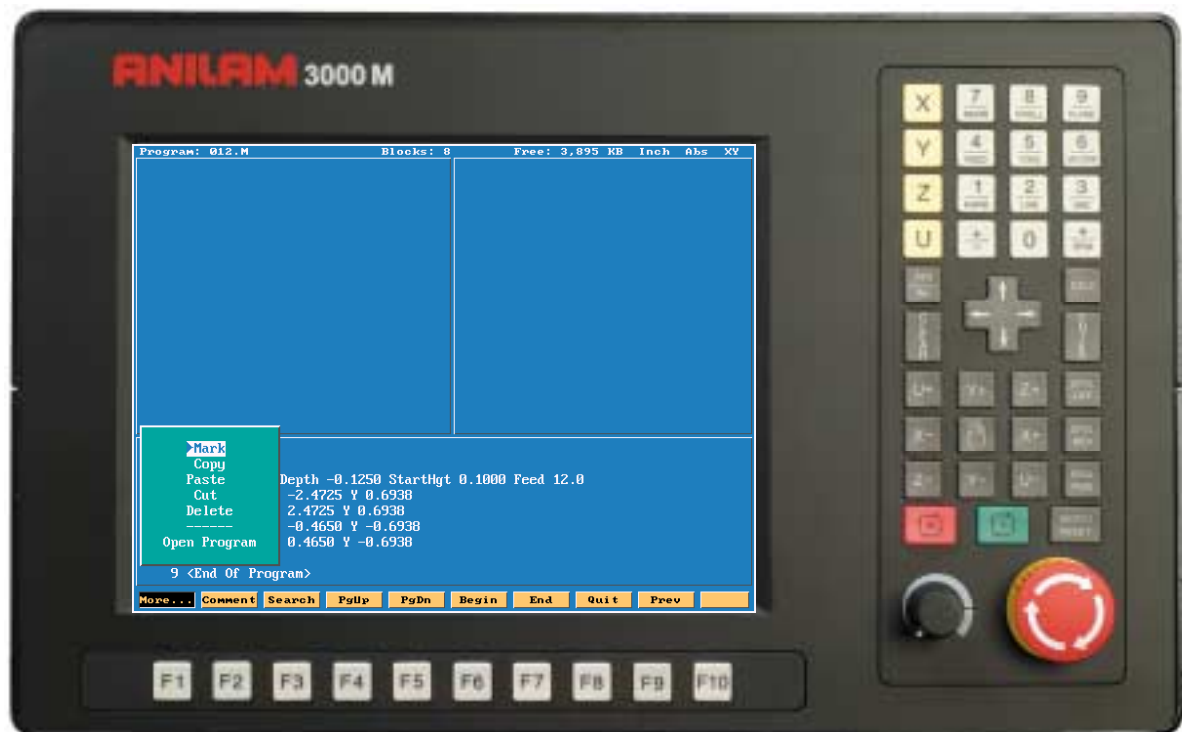

This section will deal with copying, pasting and other editing features.

Copying portions of programs and inserting them into another program.

Press **F2** **Program**

Press **F2** **Create**

Type program name 012.

Press **F4** **Edit**

```
1 Dim Abs  
2 Tool# 1  
3 BasicDrill ZDepth -0.1250 StartHgt 0.1000 Feed 12.0  
4 <End Of Program>
```

Start writing program as above.



Softkeys will appear as above press



Press



This pop-up window will come up  
 cursor down to **Open Program**.

Press

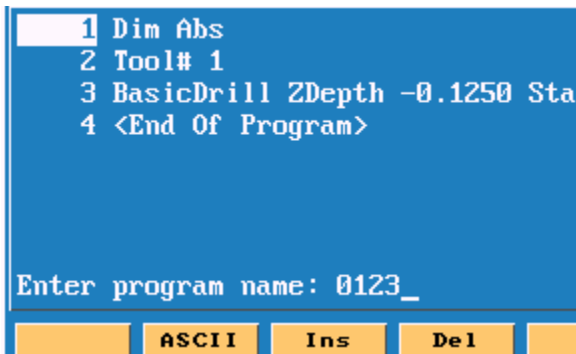

Enter name of program number (0123)

that you need to copy from press



New program will now be on screen.

```
3 PeckDrill ZDepth -1.5000 StartHgt 0.  
4 Rapid X -2.4725 Y 0.6938  
5 Rapid X 2.4725 Y 0.6938  
6 Rapid X -0.4650 Y -0.6938  
7 Rapid X 0.4650 Y -0.6938  
8 DrillOff  
9 Rapid X 0.0000 Y 0.0000 Z 0.0000
```

Press **F9** **Misc** Press **F1** **More...**



Press **ENTER** on mark.

```
3 PeckDrill ZDepth -1.5000 StartHgt 0.1000 Pec  
4 Rapid X -2.4725 Y 0.6938  
5 Rapid X 2.4725 Y 0.6938  
6 Rapid X -0.4650 Y -0.6938  
7 Rapid X 0.4650 Y -0.6938  
8 DrillOff  
9 Rapid X 0.0000 Y 0.0000 Z 0.0000 Tool# 0
```

Put high light on first block be to be copied. Press **ENTER**

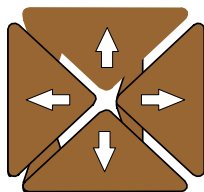

Use arrow keys to mark all blocks required.

Press **F1** **More....**



Press **ENTER**



Enter original program number.

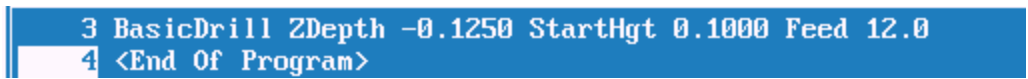

High light block #4 (End of Program.)

Press **F1** **More....**



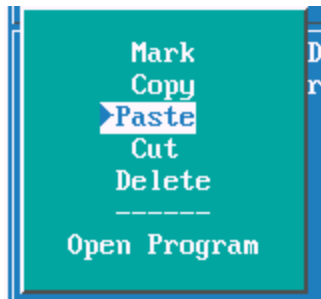

High light **Paste** press

E  
N  
T  
E  
R

```
1 Dim Abs
2 Tool# 1
3 BasicDrill ZDepth -0.1250 StartHgt 0.1000 Feed 12.0
4 Rapid X -2.4725 Y 0.6938
5 Rapid X 2.4725 Y 0.6938
6 Rapid X -0.4650 Y -0.6938
7 Rapid X 0.4650 Y -0.6938
8 DrillOff
```

It inserted lines 4 - 8 into program #012.

Cut is used remove a section of program once it's marked.

Delete will cut pieces of marked program out.

## 3000M Calculators

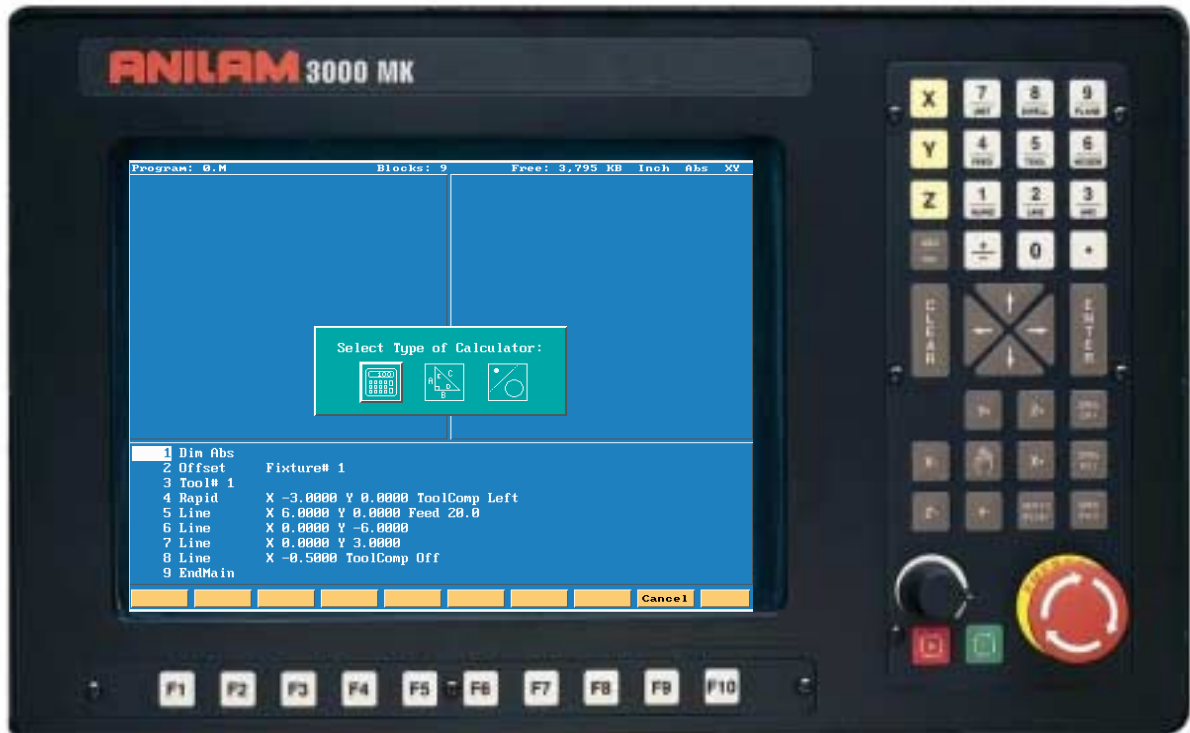

To get to calculator Press



Press



Box will appear as below.

1. Pocket.
2. Rightangled triangle.
3. Geometery

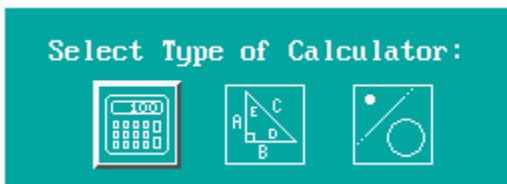

The box with the hight around it is the active one. In this case it is the left hand box.

Press **ENTER** screen will appear as below.

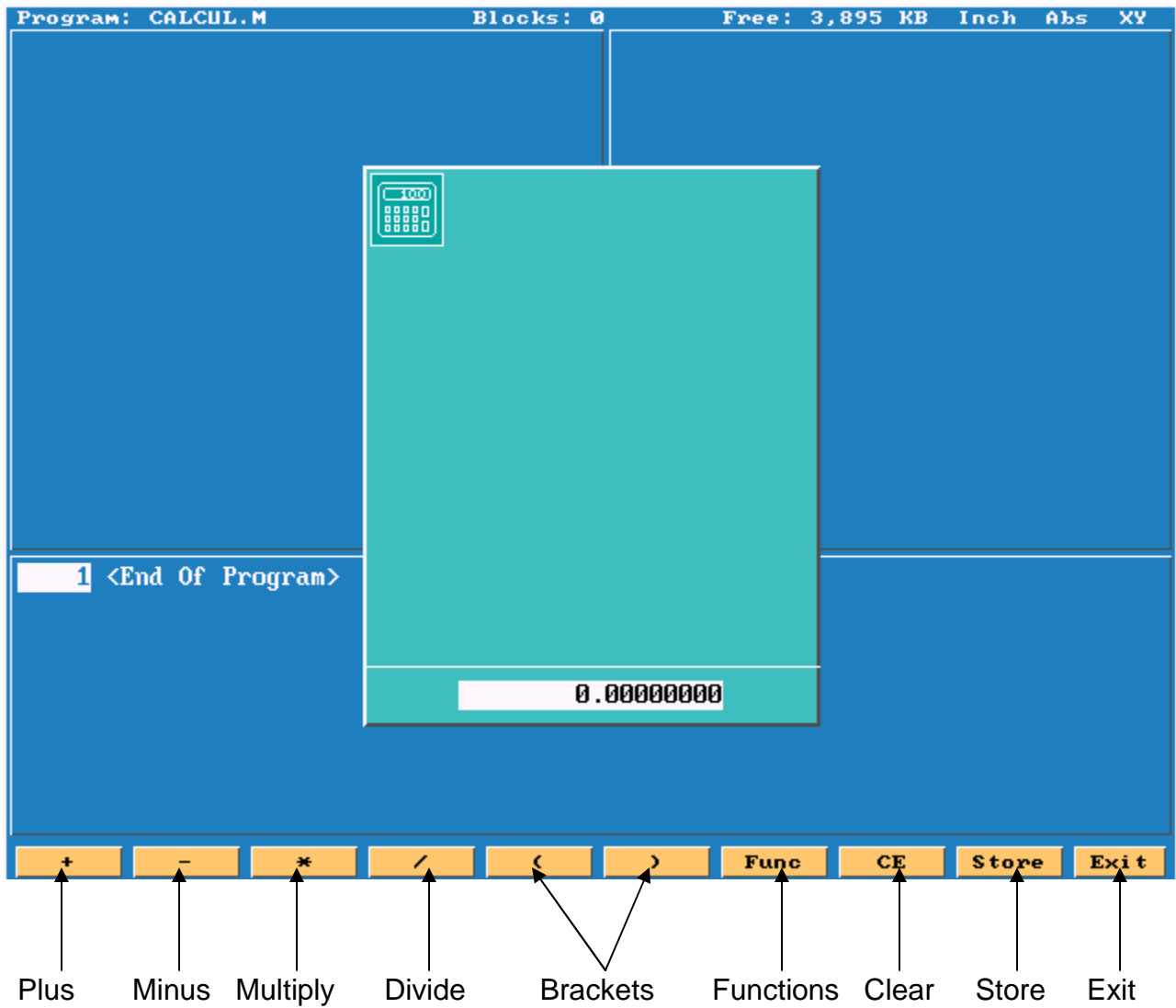

When **F7** **Func** is pressed the listed functions are available.

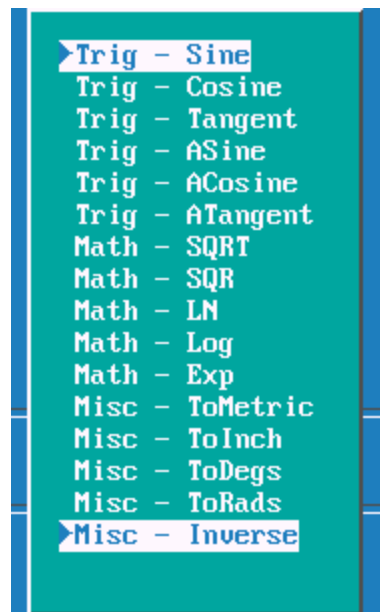

These functions allow you to do trig and math problems.

High light center icon , this is rightangled triangle calculator.

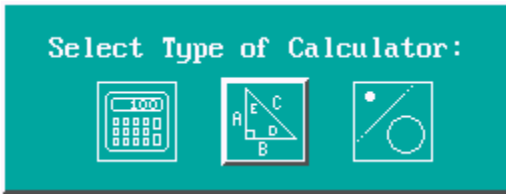

**E  
N  
T  
E  
R**

Press screen will appear as below.

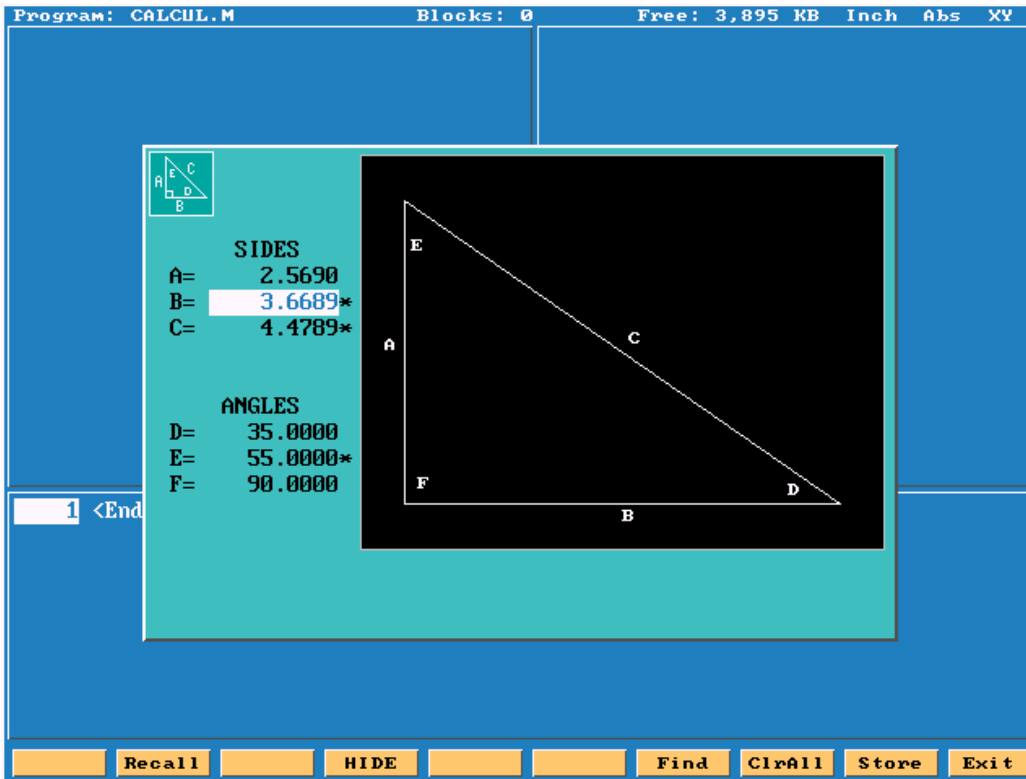

Enter any 2 sides or a side and an angle press all of the blanks will be filled in , the calculated dimensions will have an asterisk behind them. They can be stored and recalled later into a program.

**F7**

**Find**

Hight light right icon , this is the geometry calculator.

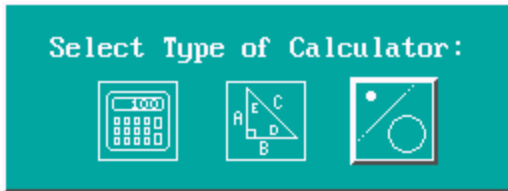

**E  
N  
T  
E  
R**

Press screen will appear as below.

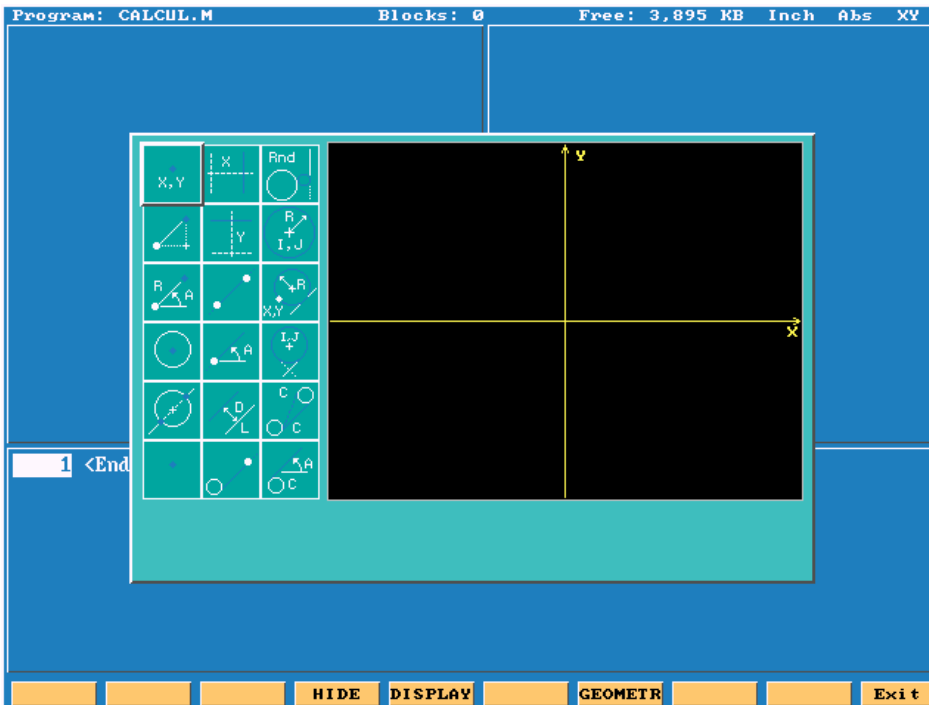

This calculator allows us to generate lines, points and circles. We will need to generate points at all intersections , as points are the only items we can recall.

The soft keys will appear as below.



<b>F4</b>	<b>HIDE</b>	Allow you change from calculator to program mode.
<b>F5</b>	<b>DISPLAY</b>	See below
<b>F7</b>	<b>GEOMETR</b>	See below
<b>F10</b>	<b>EXIT</b>	Exit Geometry calculator.



Fit to screen.  
 Zoom in to an area on the screen.  
 Redraw at current size.  
 Halfs the screen size.  
 Doubles screen size.

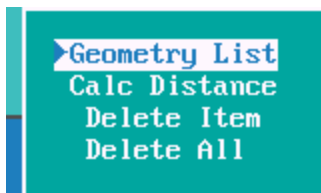

Lists all geometry.  
 Calculates distance between two points.  
 Deletes an item, need to give item number.  
 Deletes all geometry.



**Point Definitions**

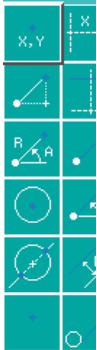

- Point defined by co-ordinates **X** and **Y**
- Point at a position **X & Y** from a previously defined point
- Point at a distance **R** and an angle **A** from a previously defined point
- Point at the centre of a circle
- Point at an **INTERSECTION** between 2 elements
- Point previously defined

**Line Definitions**



- Vertical Line at a distance **X** from datum
- Horizontal Line at a distance **Y** from part centreline
- Line passing through 2 points
- Line passing through a point at an angle **A**
- Line parallel to another line **L** at a distance **D**
- Line tangent to a circle passing through a point

**Arc Definitions**



- Circle tangent to 2 geometry elements
- Circle defined by a Centre **I & K** with a radius **R**
- Circle passing through a point **X & Y** with a radius **R**
- Circle tangent to a line with a centre **X & Y**
- Line Tangent to 2 circles
- Line tangent to a circle at an angle **A**

From the drawing below we are going to get all points required to program an irregular pocket.

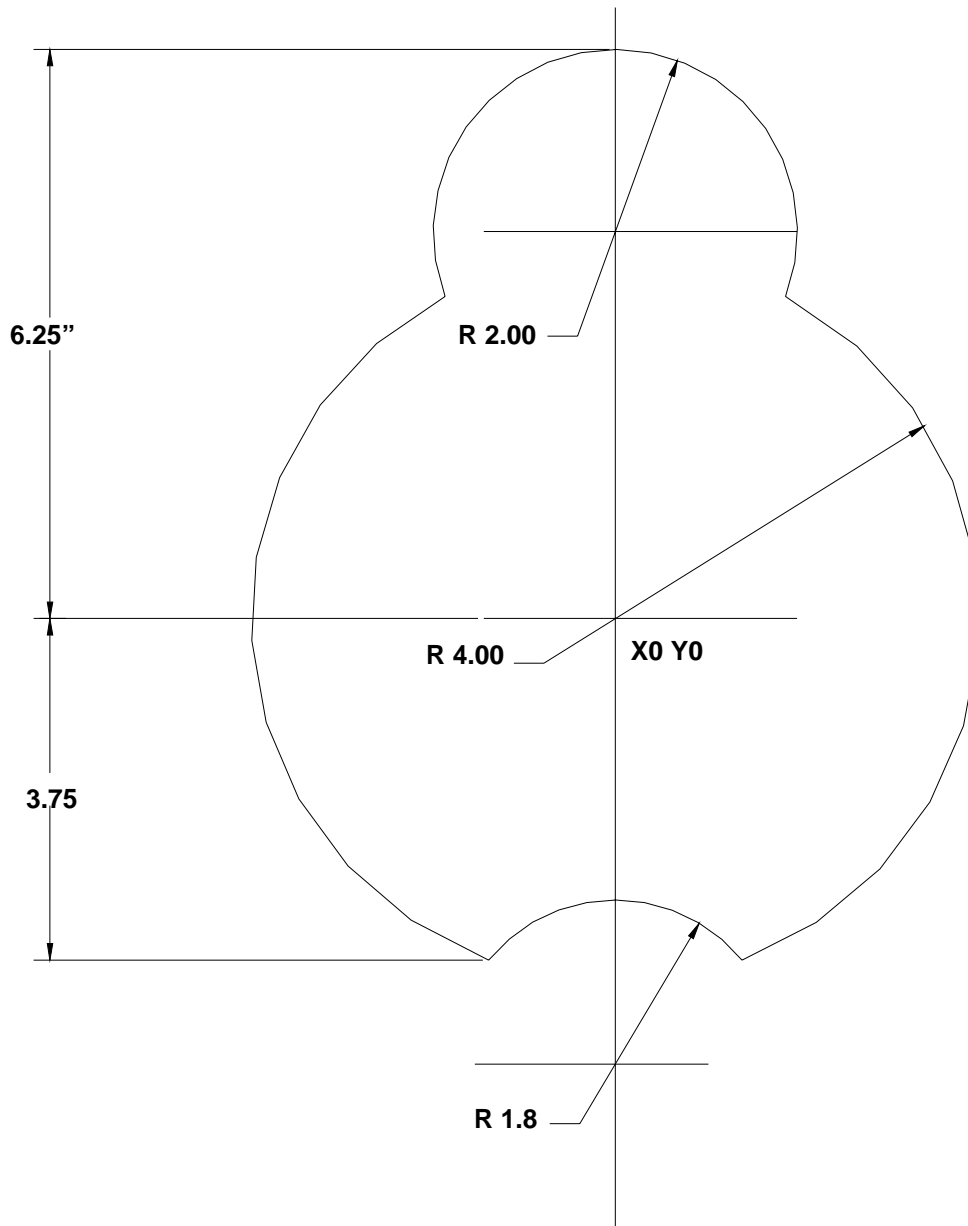

The first element to find is the 4.00 circle

Press **F4** **Edit** press **F7** **Calc**

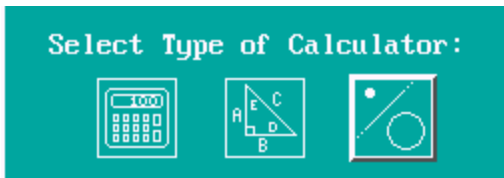

The third icon is high lighted press

**E  
N  
T  
E  
R**

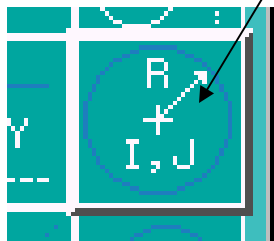
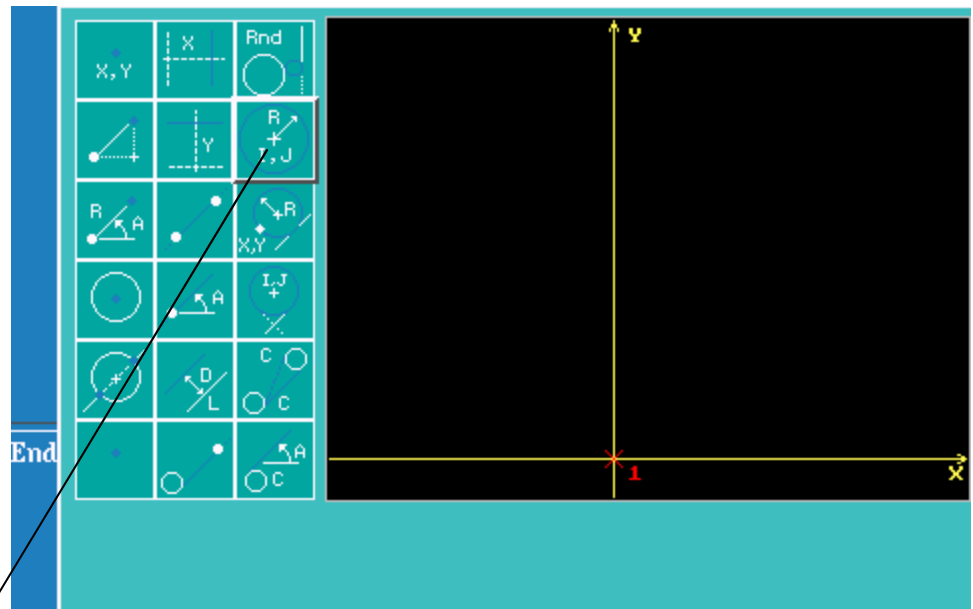

Press

**E  
N  
T  
E  
R**

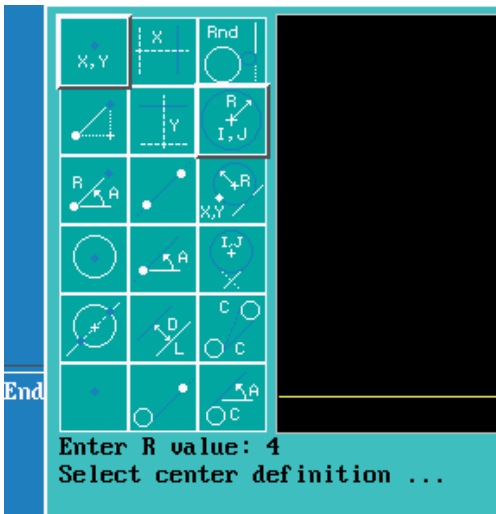

When **ENTER** is pressed screen will ask for Radius value, in this case 4., zero's not required.

Press **ENTER** It will now ask for a center definition and top left icon is high lighted. This is one to use in this case.

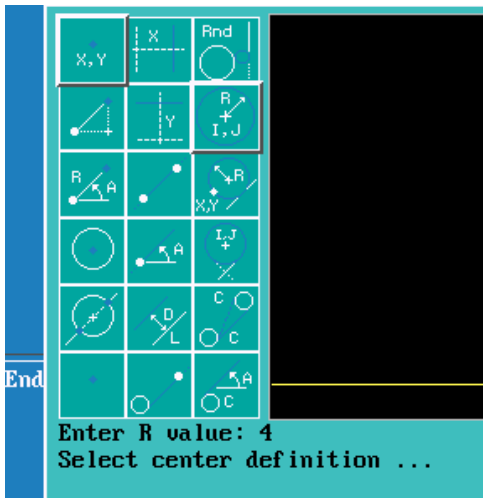

Press **ENTER**

It will now ask for an X value, in this case it 0 ,so press

**ENTER**

It will now ask for an Y value, in this case it 0 ,so press

**ENTER**

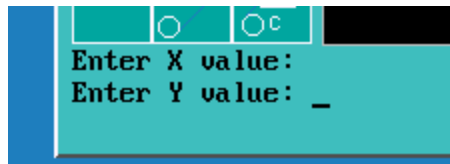

The circle will now appear on the screen, if it show as a dot on screen

press

**F5**

**DISPLAY**

select **FIT** press

**ENTER**

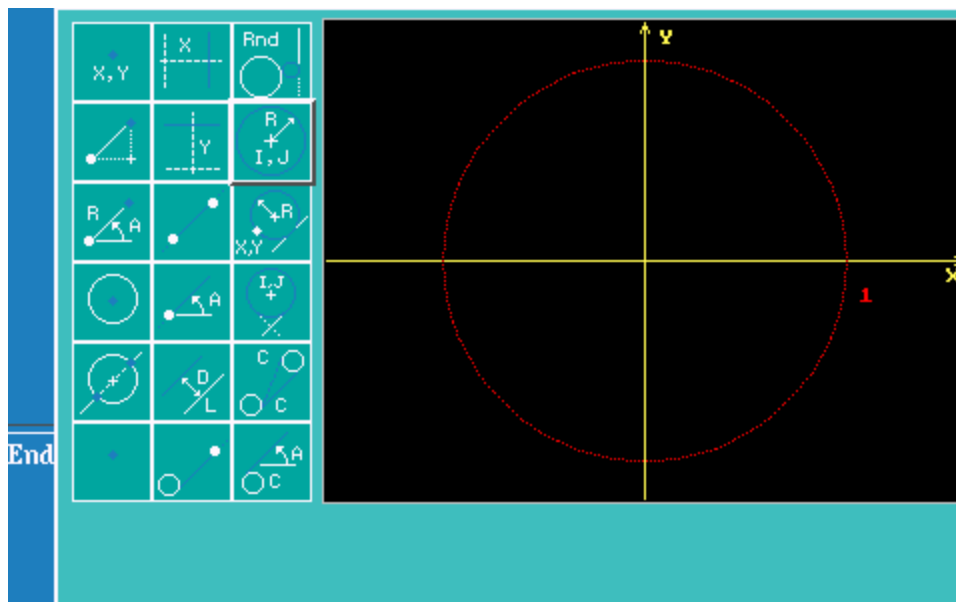

The 2" circle will now be entered. Use the same icon as before. Radius 2" use same center icon **X 0** and **Y4.25** press **ENTER**.

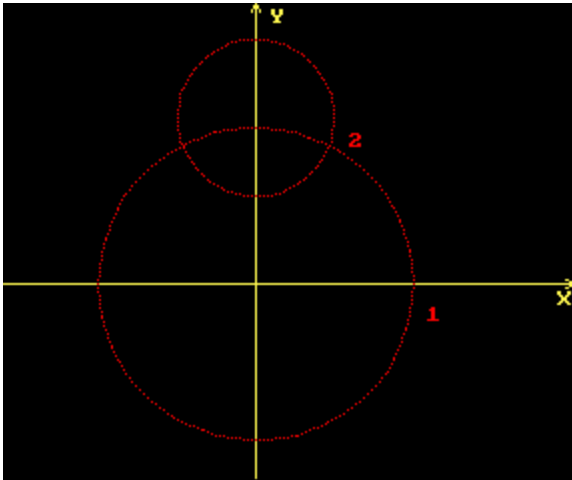

Second circle will now appear on screen, it may be necessary to fit again.

**Note:**The first circle has a 1 beside it and second has a 2. Each element will be numbered.

The next element we need is a line at **Y-3.75**.



Select **Y Line** icon and enter **-3.75**.

**E  
N  
T  
E  
R**

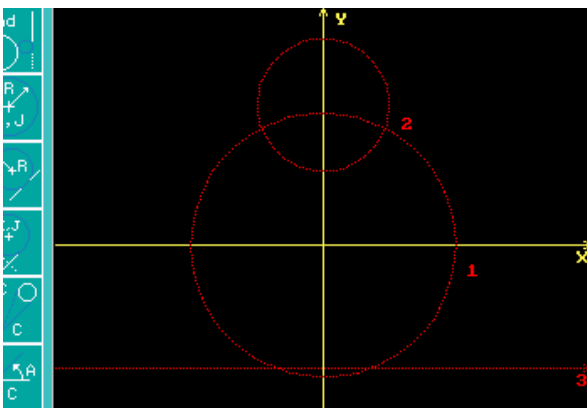

There is now an element 3.

There is now enough geometry to find all the intersect required to program this part.

It is only possible to recall points into a program, so the thing that has to be done is find the points at all intersects using the icon below.

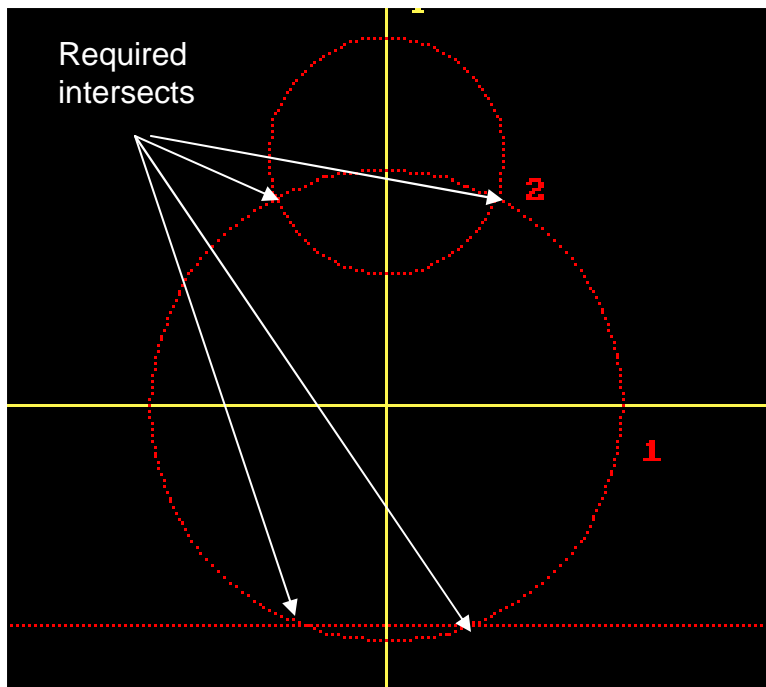

The first intersect is between element 1 & 2 on the left side.



Select the icon with a line going through a circle.

Enter number of first element: 1  
 Enter number of second element: 2  
 Select 1-2: \_

**E  
N  
T  
E  
R**

Press **ENTER** select first element #1 select second #2, as there are two intersects

there is a choice of 1 or 2 in this case the desired one is #1.

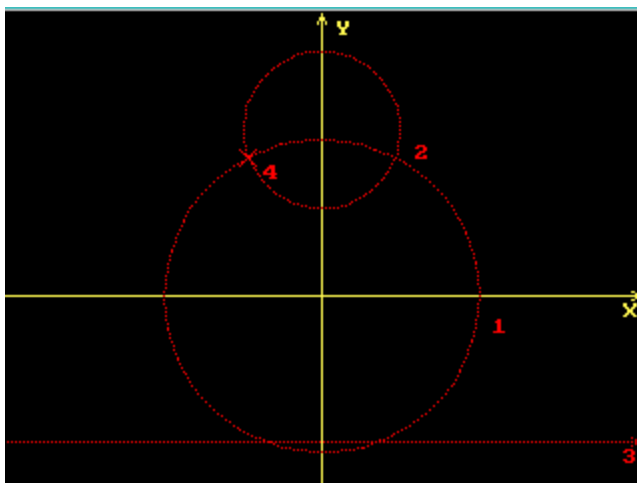

There is now an element #4 which is the intersect between #1 And #2.



Using same icon, find intersects between 1 & 3, two places and 1 & 2 right side.

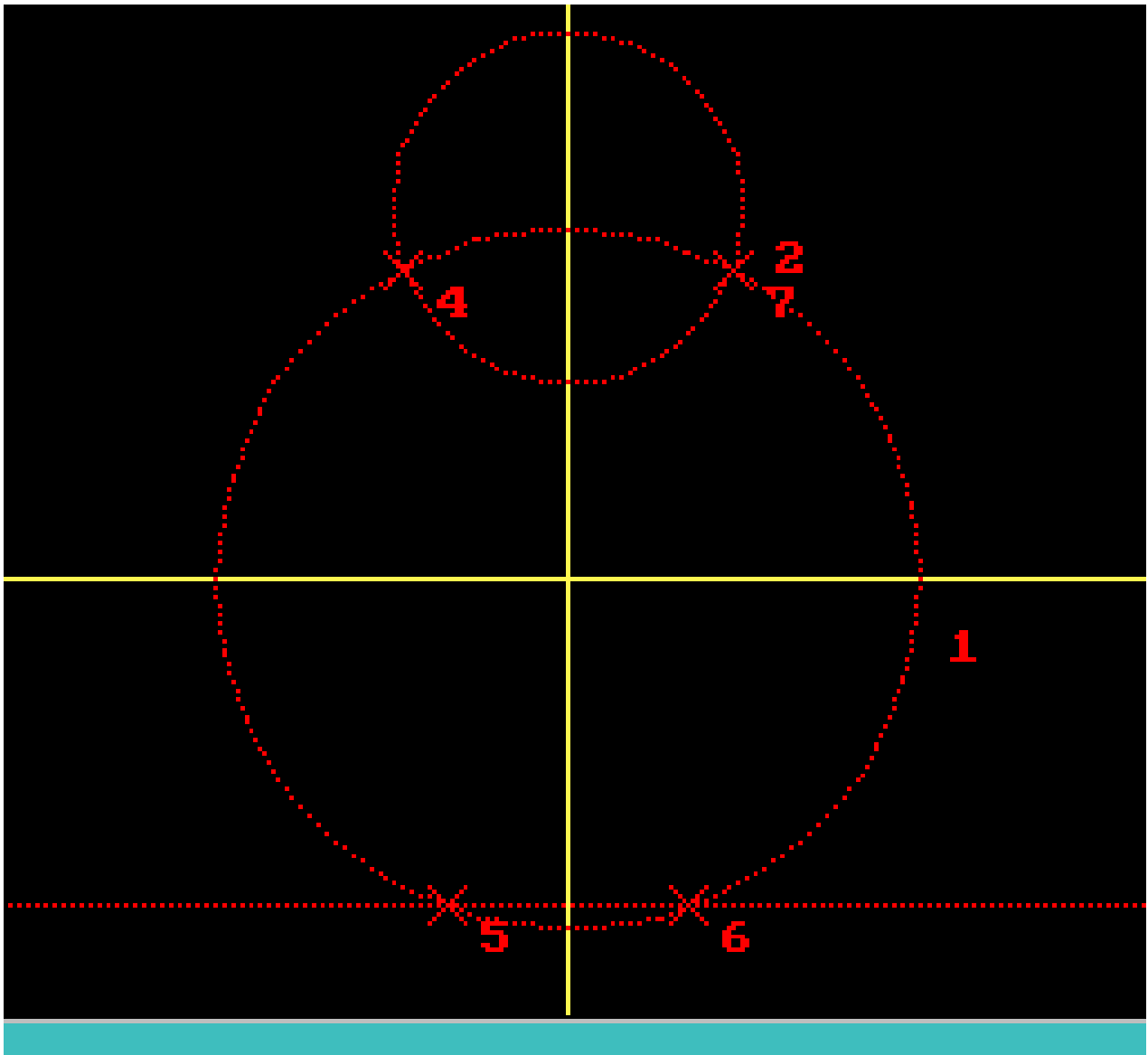

Above is completed geometry, with all intersections marked with a point.

**Writing program to pocket this shape.**

Below is how main program would look, the next thing to do is write the profile of part to be pocketed.

```

Dim Abs                * Absolute dimensioning
Rapid   Z 0.0000 Tool# 0  *Clear all offsets
Tool# 1                * Call tool #1
Pocket   Sub#1 StartHgt 0.1000 Zdepth -0.2500 Angle200 Stepover 0.3500
          FinStock 0.0100 RampFeed 2.0 RoughFeed 15.0 FinFeed 15.0
          *Pocket cycle requires a subroutine of profile.
          *Cutter compensation is built into cycle.
          *Angle is because of starting on a radius.
Rapid   Z0.0000 Tool# 0
EndMain
Sub 1                * Subroutine #1
Rapid   X 0.0000 Y6.2500 * This is the top 2" circle and the start point.
    
```

The next point needed is intersect between 2"radius and 4" radius circles.

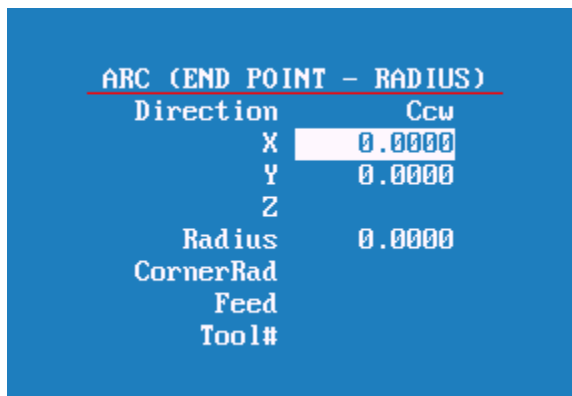
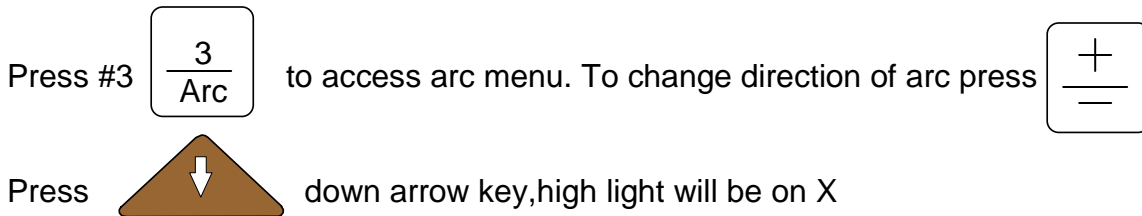

Press

**F2**

**Recall**

The screenshot shows the 'ARC (END POINT - RADIUS)' menu with the following data:

ARC (END POINT - RADIUS)			
Direction	Ccw		
X	0.0000		
Y	0.0000		
Z			

Below the menu is a 'Select point:' list:

Select point:			
1.	X	0.0000	Y 0.0000 [C]
2.	X	0.0000	Y 4.2500 [C]
4.	X	-1.8685	Y 3.5368 [P]
5.	X	-1.3919	Y -3.7500 [P]
6.	X	1.3919	Y -3.7500 [P]
7.	X	1.8685	Y 3.5368 [P]

The graphical display shows a coordinate system with a circle and points 1 through 7. A red arrow points to point 4, labeled 'Point Required #4'.

The letter C at end of line means circle center and P means point.

Move high light down to #4. Using

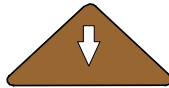

key press

**ENTER**

press

**ENTER**

The flowchart shows the following sequence of screens:

- 'Select point:' menu with point 4 highlighted.
- 'Select term:' menu with 'Both X and Y' selected.
- 'ARC (END POINT - RADIUS)' menu with the following data:

ARC (END POINT - RADIUS)			
Direction	Ccw		
X	-1.8685		
Y	3.5368		
Z			
Radius	0.0000		
CornerRad			
Feed			
Tool#			

Dimensions for X & Y will be input into program, move cruser down to Radius enter 2".

ARC (END POINT - RADIUS)			
Direction	Ccw		
X	-1.8685		
Y	3.5368		
Z			
Radius	2.0000		
CornerRad			

**F10**

**Save**

9 Arc Ccw X -1.8685 Y 3.5368 Radius 2.0000

The same can now be done with points 5,6 & 7, the last point will be the same as the first X0 Y6.26 end point of 2" arc.

The following is how the program should look when complete.

```
Dim Abs
Rapid      Z 0.0000 Tool# 0
Tool# 1
Pocket     Sub# 1 StartHgt 0.1000 ZDepth -0.2500 Angle 200.0000 Stepover 0.3500
FinStock 0.0100 RampFeed 2.0 RoughFeed 15.0 FinFeed 15.0
Rapid      Z 0.0000 Tool# 0
EndMain
Sub 1
Rapid      X 0.0000 Y 6.2500
Arc Ccw    X -1.8685 Y 3.5368 Radius 2.0000
Arc Ccw    X -1.3919 Y -3.7500 Radius 4.0000
Arc Cw     X 1.3919 Y -3.7500 Radius 1.8000
Arc Ccw    X 1.8685 Y 3.5368 Radius 4.0000
Arc Ccw    X 0.0000 Y 6.2500 Radius 2.0000
EndSub
```

It is now time to check the program using the draw funtion.

Press **F2** **Draw**

Press **F5** **Display** box will pop-up as shown below high light will be on fit.

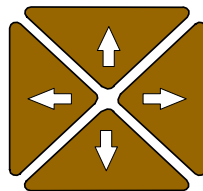
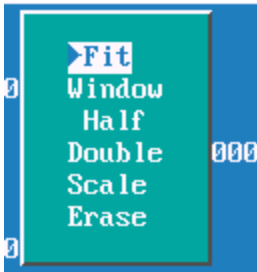

Use arrow keys to move high light up and down.

Press **ENTER**

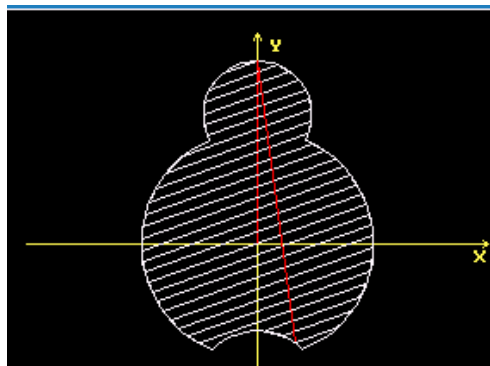

If all looks good in draw part is ready to cut.

Press **F10** **Exit**

Press **F10** **Exit**

## 3000M Program Example

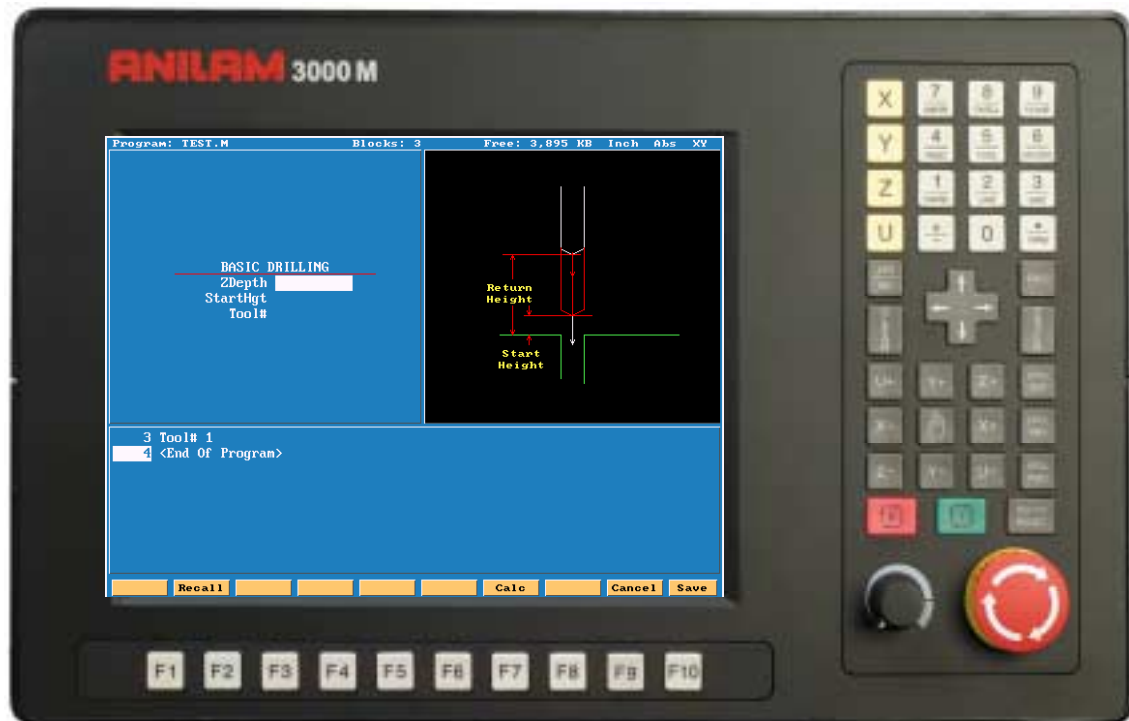

## Typical starting program

Program: BASEPR01.M      Blocks: 10      Free: 3,795 KB      Inch      Abs      XY

X	0.0000
Y	0.0000
Z	0.0000

Block: 5  
Tool:                      Dia: 0.0000  
Feedrate: 0.0              Feed  
ToolComp: Off              Abs  
Loop: 0                      XY

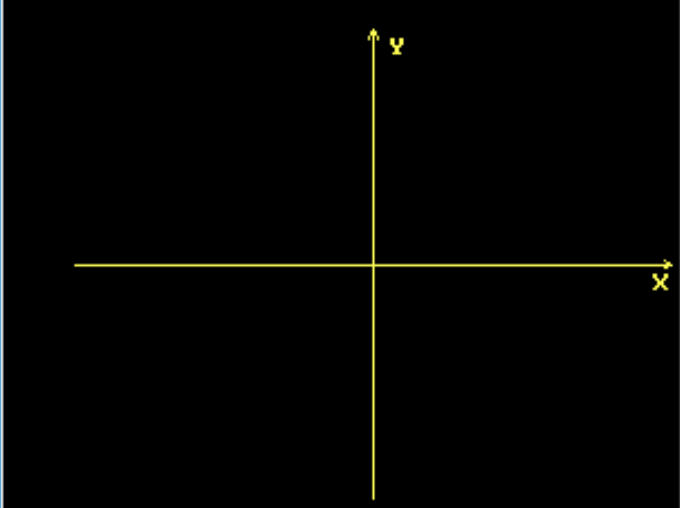

1 Dim Abs  
2 Plane XY  
3 Unit Inch  
4 Offset      Fixture# 0  
5 Tool# 0  
6 Rapid      Z 0.0000  
7 Offset      Fixture# 1  
8 Tool# 1  
9 Rapid      X 0.0000 Y 0.0000

Auto    S.Step    Motion    Text    Tool    Rapid    Start    Hold    Cancel

Press **F2** **Edit** to enter editor.



<b>F1</b>	<b>Teach</b>	Dimension can be entered into by F2 Rapid , F3 feed or Modal.
<b>F2</b>	<b>Draw</b>	Simulation draw allows checking program before run in auto.
<b>F3</b>	<b>Drill</b>	Drilling canned cycles.
<b>F4</b>	<b>Pocket</b>	Pocketing canned cycles.
<b>F5</b>	<b>Mill</b>	Mill operations.
<b>F6</b>	<b>Tool</b>	Tool Page.
<b>F7</b>	<b>Calc</b>	Calculators Pocket , Right-angled triangle & Geometry.
<b>F8</b>	<b>Sub</b>	Various auxiliary functions.
<b>F9</b>	<b>Misc</b>	Miscellaneous functions
<b>F10</b>	<b>Exit</b>	Exit to program page



Before entering **Teach Mode** you must create a program.

Press **F1** **Teach** to enter teach mode.



<b>F1</b>	<b>Teach</b>	Exit from <b>Teach Mode</b> .
<b>F2</b>	<b>Rapid</b>	Inputs a <b>Rapid</b> move.
<b>F3</b>	<b>Line</b>	Inputs a <b>Line</b> move.
<b>F4</b>	<b>Modal</b>	Inputs a <b>Modal</b> move.

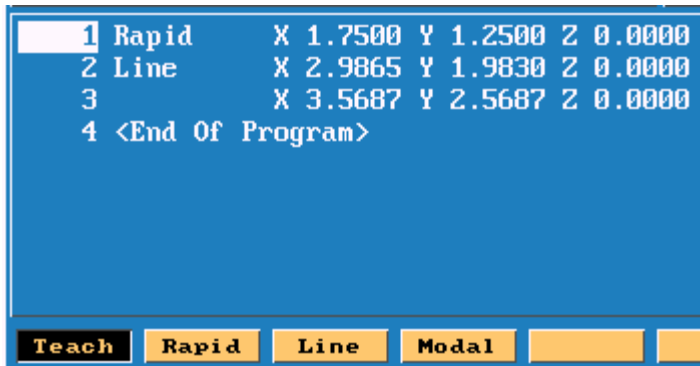

1. Rapid input.
2. Line input
3. Modal input

Modal meaning it will do this move the same as previous move , in this case Line.

To exit **Teach** press **F1** **Teach**

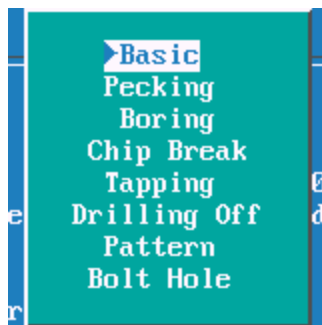
**F3****Drill**

### Drilling Cycles

<b>Basic :-</b>	Drills a hole one shot.
<b>Pecking :-</b>	Drills in steps depending on the amount of peck entered.
<b>Boring :-</b>	Feeds in And out of hole.
<b>Chip Break:-</b>	Used for deep holes , peck and then at specified depth retract all the way out of hole.
<b>Tapping:-</b>	Taps hole feeds and speed must be calculated correctly.
<b>Drilling Off:-</b>	Drilling must be turn <b>OFF</b> when done.
<b>Pattern:-</b>	Program a regular pattern of holes giving Number of holes, Distance between holes.
<b>Bolt Hole:-</b>	Full or partial bolt hole may be programmed.

**Mill**

**F5**

**Mill**



**F2**

**Rapid**

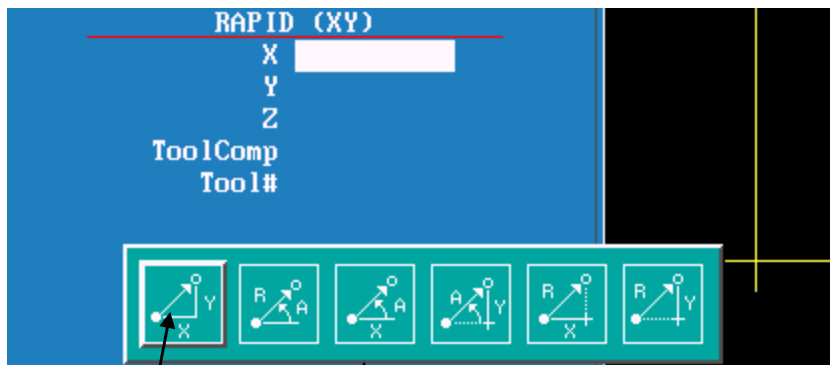

Active one has a border

These are various way of entering a line or rapid move.

**F4**

**Arc**



This is the default for arc's and will always come up looking this way. There two other chooses , end point and center or center and angle.



Note the center icon is high lighted.

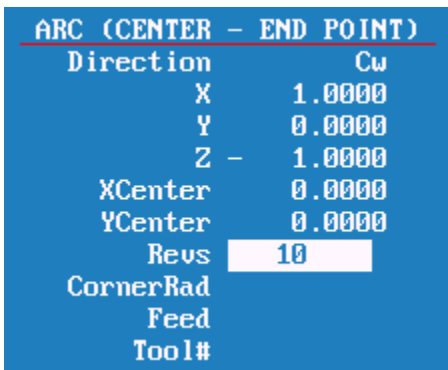

With this arc the machine is capable of milling a thread. It needs an X , Y and Z end point X , Y center point and Rev's. With Z starting at zero the inputs shown on left would cut a 10 TPI thread.

Pressing



this key will bring up following box menu.

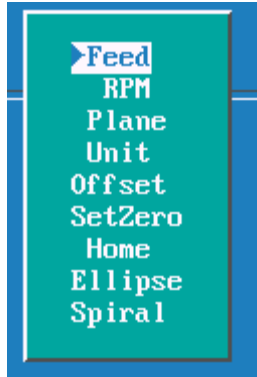

- |                |   |
|----------------|---|
| <b>Feed</b>    | Enter a feedrate on line by itself.   |
| <b>RPM</b>     | Put spindle speed on of it's own.   |
| <b>Plane</b>   | Change planes XY,XZ or YZ.  |
| <b>Unit</b>    | Inch or MM.   |
| <b>Offset</b>  | Enter fixture offset , this is an <u>absolute</u> shift relative to Machine Zero. |
| <b>SetZero</b> | <u>Incremental</u> Zero shift.  |
| <b>Home</b>    | Returns machine to home.  |
| <b>Ellipse</b> | Programs an ellipse with comp inside or outside.                                  |
| <b>Spiral</b>  | Spiral gives the ability to program tapered threads.                              |

Press



to return to previous screen.

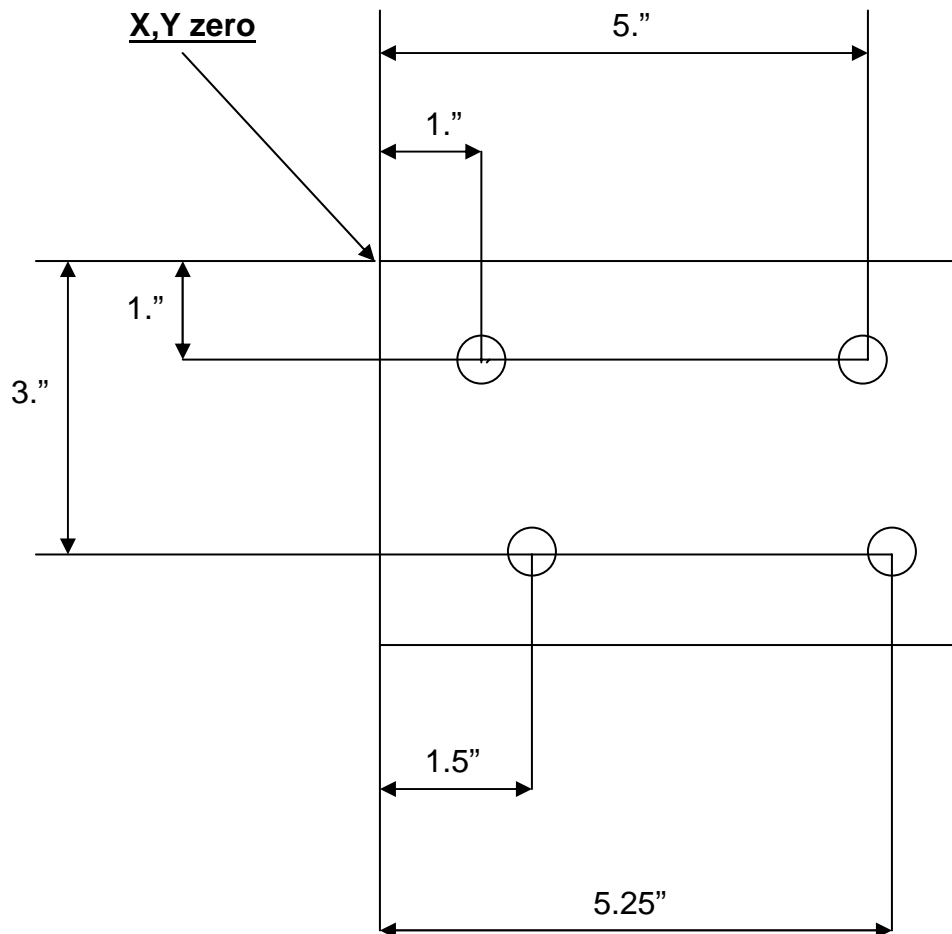

We will now write a program to center drill and drill this part, we will use a subroutine in this program because we are going to use the same dimensions twice. A subroutine is a mini program outside of the Main program that will be Called into the Main program.  
 Program lines are in **bold** print.

The first thing to do is **Create** a program.

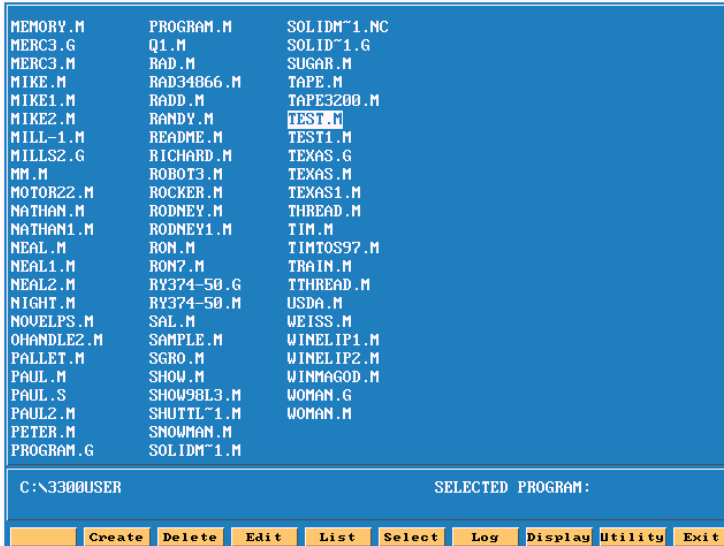

Type in a program name 8 letters, numbers or a combination of both. To type in letter use the ASCII (**F2** key) will bring up the chart.

When the name is typed in press



The program name will be entered into program page and an **.M** will be added to it.

Press **ABS INC** Press **ENTER** Set the control in absolute

1. Dim Abs

Use  to toggle between Abs/Inc.

1  
Rapid

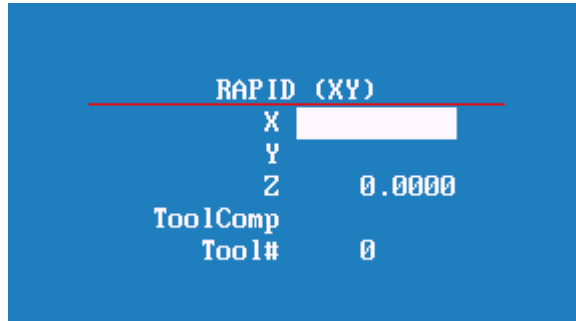

When !/Rapid key is pressed a box as show on left will appear.

2. Rapid Z0.000 Tool# 0

**F10**

**Save**

Rapid to Z home.

Press

1  
Rapid

3. Rapid X -4.000 Y 2.0 000

**F10**

**Save**

Rapid to tool change position.

5  
Tool

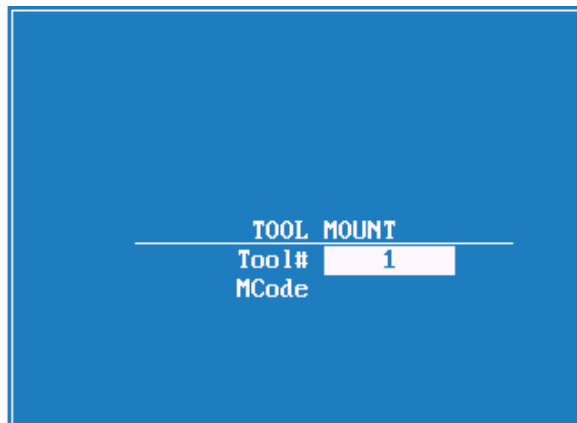

5/Tool key is press screen will look as shown on left. The Mcode would only be necessary if a tool changer is installed.

**F10**

**Save**

4. Tool# 1

Call tool #1



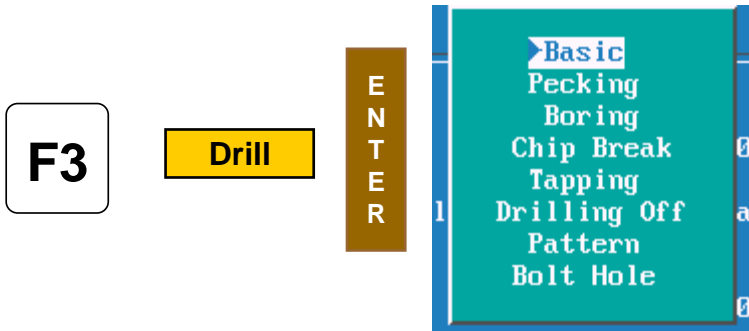

F3 Drill is selected this box will appear. These are your chose of how you are going to drill the hole , the first time we will use Basic for the center drill , the second time we will use pecking for the drill.

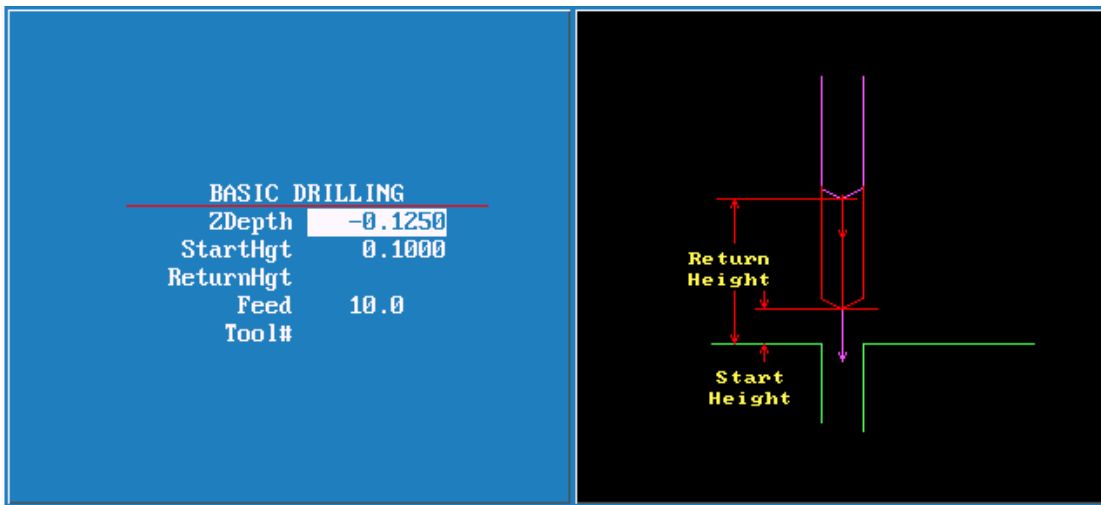

When **ENTER** is pressed the screen will appear as above.

- Zdepth = depth of hole.
- StartHgh = Distance above Surface you are drilling into.
- ReturnHgt = Distance above to retract to before moving to next hole.
- Feed = Feedrate
- Tool# = Tool# may be entered here.



**5. BasicDrill Zdepth -0.125 StartHgt 0.1000 Feed 10.0**



Press **F8** **Sub** **Sub** Function key will change as below.



<b>F1</b>	<b>Sub</b>	Enter subroutine number. A subroutine is a program entered after main program and call into main program using a <b>Call</b> .
<b>F2</b>	<b>EndSub</b>	Entered at the end of a subroutine.
<b>F3</b>	<b>Call</b>	Bring a subroutine into main program.
<b>F4</b>	<b>EndMain</b>	Ends main program.
<b>F5</b>	<b>Loop</b>	Repeats operation desired number of times.
<b>F6</b>	<b>RMS</b>	Allow subroutines to be <b>Rotated</b> , <b>Mirrored</b> or <b>Scaled</b> .
<b>F7</b>	<b>Dwell</b>	Enters <b>Dwell</b> into program , this is also available on a hot key.
<b>F8</b>	<b>MCode</b>	Enters an <b>Mcode</b> into program , also available as a hot key.
<b>F9</b>	<b>Prev</b>	Return to previous screen.
<b>F10</b>		Not used.

Press **F3** **Call**

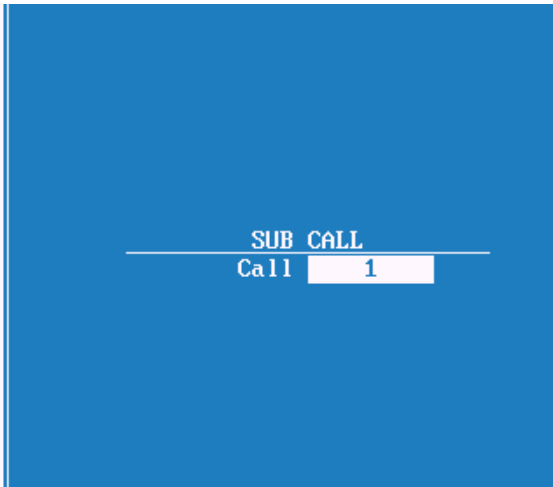

Press Key number 1



**6. Call 1**

We have now finished the with the first tool.

Press **1**  
Rapid

**F10** **Save**

**7. Rapid Z0.000 Tool# 0**

Rapid to Z home.

Press **1**  
Rapid



**F10** **Save**

**8. Rapid x -4.000 Y 2.0000**

Rapid tool change position.

Press   

**9. Tool# 2**      Activate tool #2

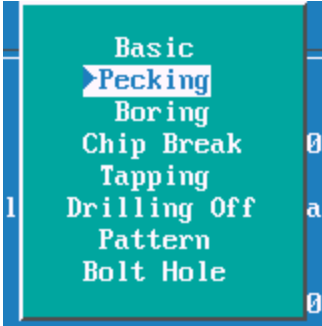
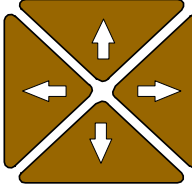
Press    

Press down arrow key to high light **Pecking** , press

**E  
N  
T  
E  
R**

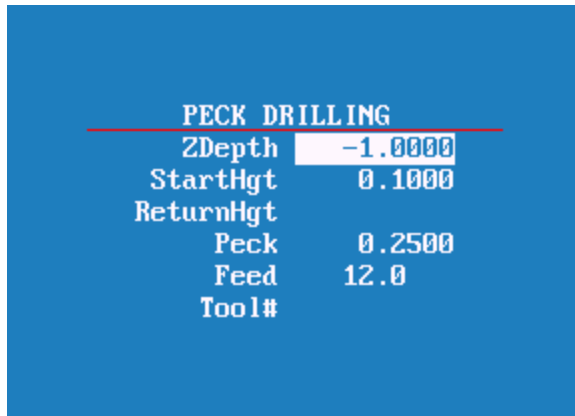

PECK DRILLING

ZDepth	-1.0000
StarHgt	0.1000
ReturnHgt	
Peck	0.2500
Feed	12.0
Tool#	

Input values  

**10. PeckDrill Zdepth -1.0000 StarHgt 0.1000 Peck 0.2500 Feed 12.0**

Press **F3** **Call**

Press Key number 1 **ENTER**

**11. Call 1**

We have now finished the with the second tool.

Press **1**  
Rapid

**12. Rapid Z0.000 Tool# 0**

Rapid to Z home.

**F10** **Save**

Press **1**  
Rapid

**13. Rapid x -4.000 Y 2.0000**

Rapid tool change position.

**F10** **Save**

Press **F4** **EndMain**

**14. EndMain**

Press **F1** **Sub** press #1 key Press **F10** **Save**

**Sub 1**

Press **1**  
Rapid

Rapid X 1.0000 Y -1.0000 press F10 save  
Rapid X 5.0000 press F10 save  
Rapid X 5.2500 Y -3.0000 press F10 save  
Rapid X 1.5000 press F10 save

**Drilling must now be turn off as soon as last hole is drilled**

Press **F9** **Prev**

Press **F3** **Drill**

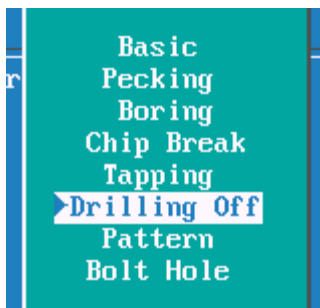

High light Drilling Off press



Press **F2** **EndSub**

**EndSub**

Program for this part is now complete.

This is above program will look in control.

1. Dim Abs
2. Rapid Z 0.0000 Tool# 0 (See note 2 below)
3. Rapid X -4.0000 Y 2.0000
4. Tool# 1
5. BasicDrill ZDepth -0.1250 StartHgt 0.1000 Feed 10.0
6. Call 1
7. Rapid Z 0.0000 Tool# 0 ( See note 3 below )
8. Rapid X -4.0000 Y 2.0000
9. Tool# 2
10. PeckDrill ZDepth -1.0000 StartHgt 0.1000 Peck 0.2500 Feed 12.0
11. Call 1
12. Rapid Z 0.0000 Tool# 0 (See note 3 below)
13. Rapid X -4.0000 Y 2.0000
14. EndMain
15. Sub 1
16. Rapid X 1.0000 Y -1.0000
17. Rapid X 5.0000
18. Rapid X 5.2500 Y -3.0000
19. Rapid X 1.5000
20. Drilling Off
21. EndSub

**Note**

If running parts on a machine with **Homing** a fixture offset may be added to program at Line #2 or #3 to get to part zero.

With Bed Mill Z0 Tool#0 not required , just move **Z** axis up plus to a convenient height to change Tools.( I.e. Z5.0000.)

Now that the part is programmed , we need to verify that it is correct.  
To do this we use **Draw** .

Press **F9** **Prev** to return to main edit screen.

Press **F2** **Draw** to enter **Draw Mode**.



<b>F1</b>	<b>Draw</b>	Not used
<b>F2</b>	<b>Draw</b>	Exit draw mode.
<b>F3</b>	<b>Run</b>	Runs program in simulation draw.
<b>F4</b>	<b>View</b>	There are four views available XY,XZ,YZ and Iso.
<b>F5</b>	<b>Display</b>	Calculates the window size to show complete part.
<b>F6</b>	<b>Draw</b>	Not used
<b>F7</b>	<b>Draw</b>	Not used
<b>F8</b>	<b>Draw</b>	Not used
<b>F9</b>	<b>Parms</b>	Draw parameters.
<b>F10</b>	<b>Exit</b>	Exit to main edit screen.



Press **F5** **Display** box will pop-up as shown below high light will be on fit.

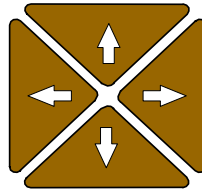
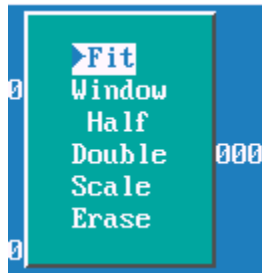

Use arrow keys to move high light up and down.

Press **ENTER**

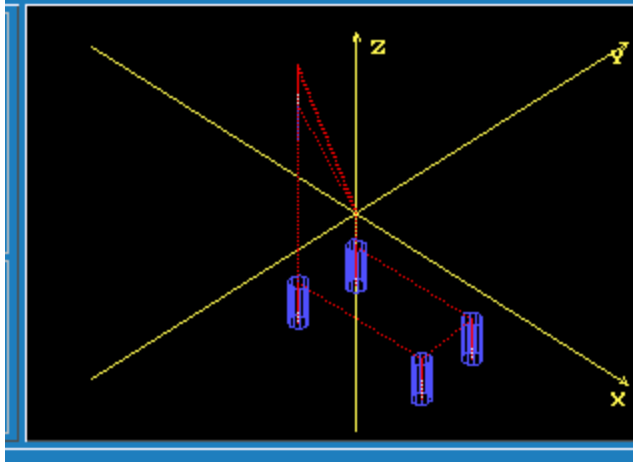

Red lines are **Rapid** moves.  
 White Lines are **Feed** moves.  
 Yellow are axis lines.  
 Blue represent the tools sizes ,In this case tool #1 is center drill with .0000 Diameter and tool #2 is .5000 drill.

When **F3** **Run** or **F5** **Display** is press soft key will change as below.



<b>F1</b>	<b>Auto</b>	Will run program all the way through.
<b>F2</b>	<b>S.Step</b>	Ever time <b>Start</b> is pressed runs one program line.
<b>F3</b>	<b>Motion</b>	Runs a move ever time <b>Start</b> is pressed.
<b>F4</b>	<b>Text</b>	If high lighted will scroll text.
<b>F5</b>	<b>Tool</b>	Will show tools if high lighted.
<b>F6</b>	<b>Rapid</b>	Displays <b>Rapid</b> moves when high lighted.
<b>F7</b>	<b>Start</b>	Starts draw moves one line in S Step or Motion.
<b>F8</b>	<b>Hold</b>	Stop draw until Start is pressed.
<b>F9</b>	<b>Cancel</b>	Cancel current drawing.
<b>F10</b>		Not used

Program has been written and checked on simulation graphics , it is now time to set **Part zero** and **Tool offsets**.

Press **F10** **Exit** twice to return to **Manual** page .

Using **Jog** keys find edge of part or center of hole where you want **X0** and **Y0** are to be located .

If machine does not have homing press **X0** **ENTER** display will change to zero

on X axis , use same procedure on **Y** axis .

If machine has **Home Jog** to **X0** , **Y0** as above then press **F9** **Tool** Softkeys will change as shown below.



Press **F1** **OFFSET**

No.	Diameter	Length	Spindle RPM	Spindle Direction	Coolant
1	0.1000				NONE
Fixture Offsets					
			X	Y	Z
1.			0.0000	0.0000	0.0000
2.			-20.0000	-6.0000	0.0000
3.			-9.0000	-6.0000	0.0000
4.			-6.0000	-6.0000	0.0000
5.			-3.0000	-6.0000	0.0000
6.			0.0000	-6.0000	0.0000
7.			0.0000	0.0000	0.0000
8.			0.0000	0.0000	0.0000
9.			0.0000	0.0000	0.0000
1	0.1000				NONE

If machine is at **X0** press **F5** **CalibX**

Do the same with **Y** **F6** **CalibY** Press **F10** **Exit**

You are now back at the tool Page .  
The thing to do is set tool length Offsets.  
Check to see that Tool #0 is active .  
Put tool #1 into spindle jog down to top of part .  
Check to see that high light is on Tool #1 .

Now press  

Move spindle up , put in tool #2 and repeat above process , until all tools offsets

are set and press .  

Control is now back at **Manual** and ready to cut part.

Press  

Put **Tool #1** in spindle press 

Machine will stop on **Tool Change** press 

Machine will rapid **X** and **Y** position of first hole and then **Z** rapid to .1000 above part . Next it will then feed to give depth and rapid back out of the hole and rapid to next hole and repeat process until all holes are drilled.

It will now on **Tool Change** and repeat process for tools #2 and #3.

# ANILAM

## 3000M DXF Converter



DXF file can be converted into 3000 machine programs using the Offline software.

The DXF files are stored in the Program Page.

When going to Program Page only .M file will be displayed,

press **F8** **Display** twice, this will display all files.

If DXF is on disk it needs to be copied into **C:\User** directory.

press **F7** **Log** select **A:**

High light required DXF program press **F9** **Utility** Copy to **C:**

High light DXF program



A screenshot of a file list with a blue background. The files listed are: UPARM2.DXF, XE2436-1.DXF (highlighted), XE2436-1.FXD, and XE2436-1.M.

Press **F9** **Utility** high light DXF Converter

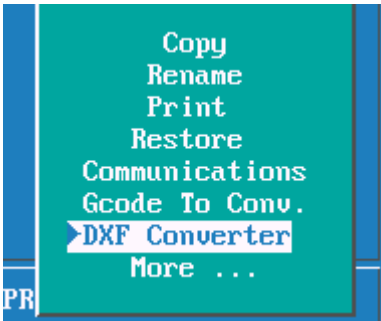

A screenshot of a menu with a teal background. The options are: Copy, Rename, Print, Restore, Communications, Gcode To Conv., DXF Converter (highlighted), and More ...

Press **ENTER**

File name

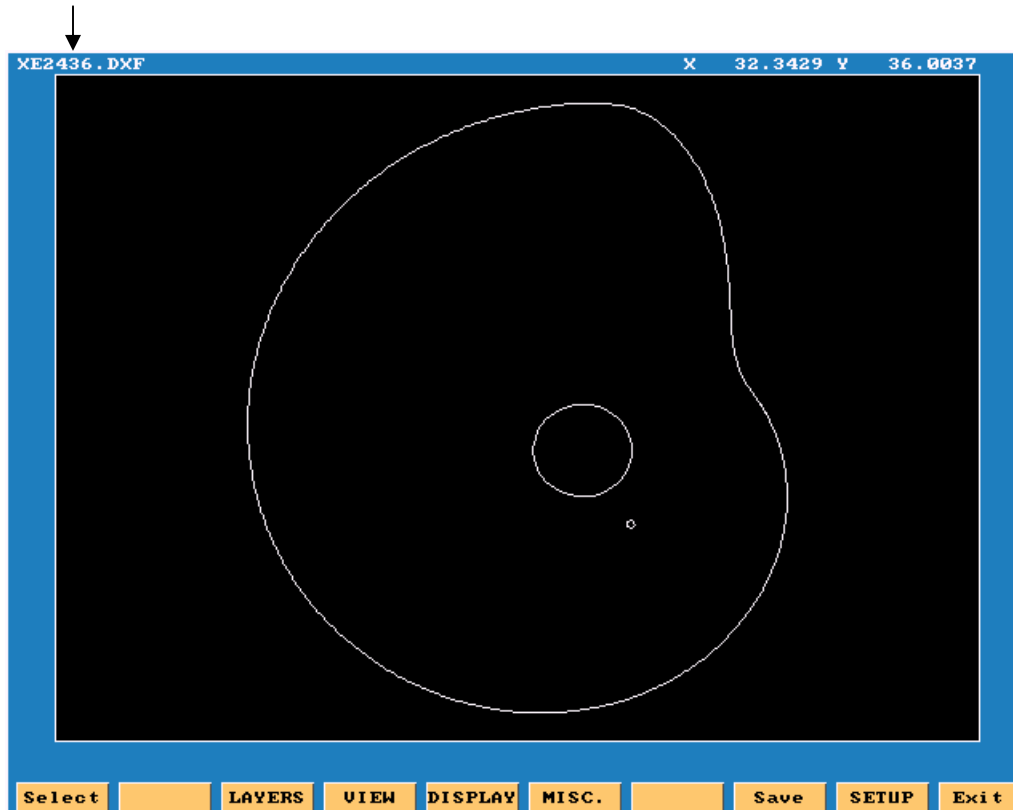

- Select:** Used when selecting elements on drawing.
- Layers:** Allows layer on drawing to be turned Off or On.
- View:** XY,XZ,YZ or isometric.
- Display:** Fit, window, redraw, half or double.
- Misc.** See below.
- Save:** Saves program with .G once converted.
- Setup:** Allows set of inputs and outputs.

**Entity Info**  
 Set Shift  
 Toggle Endpoints  
 Link or New Shape

Information on a particular entity.  
 Set shifted zero in the **set-up**.  
 Toggle end points of entities **on** or **off**.  
 When turn **ON** will ask question link or new shape.

Zero on most drawings is usually not at a point that is convenient for programming, so there is a way it can be changed.

In the case of current drawing, the center of the hole in center of part is the best point X0 Y0. There are two methods find new zero's from an entity on drawing.

1. To do this Press the Ctrl key and hold it down put mouse point on to circle and press left mouse key, it will change to yellow, release keys.
2. Press **MISC** key select **Entity Info** press **ENTER** select entity using mouse

it will turn yellow

At the bottom of screen X, Y, and Z cordinate will appear and also circle diameter.

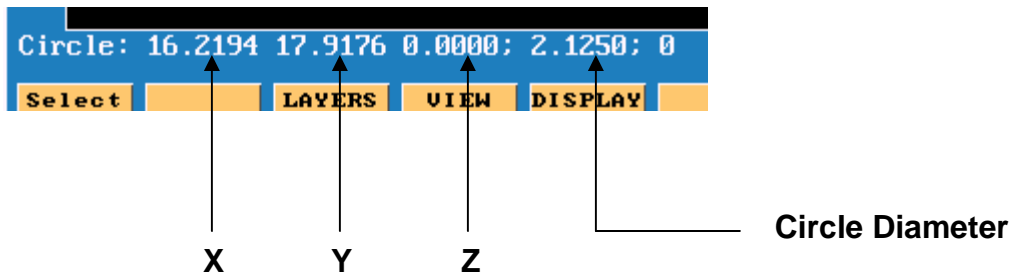

Now press **ALT** key and letter **T** at the same time first method or **MISC** **Set Shift** press **ENTER**.

This will in put these coordinates in to the **SETUP** and change **X0 Y0** to the center of hole.

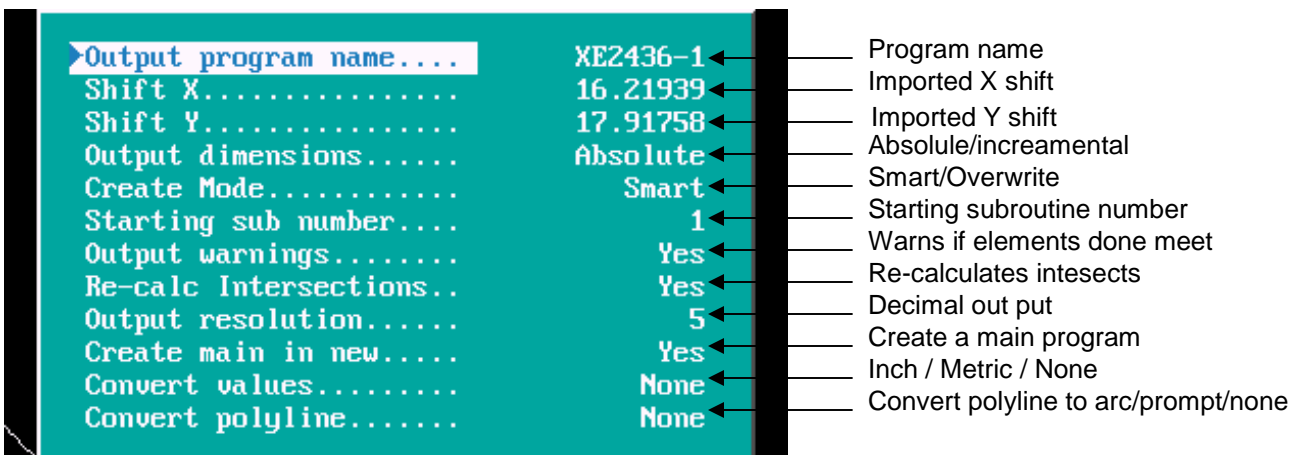



Press **F10** **Exit**

Press **ALT**key and letter **F**key at the same time, this will mark the end of each element.

Press **F5** **DISPLAY** high light **Window**  press **ENTER**

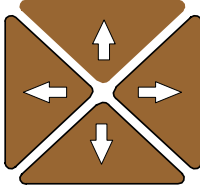
A box will appear on screen move over using 

press **F6** **Compress** position box as shown below press **ENTER**

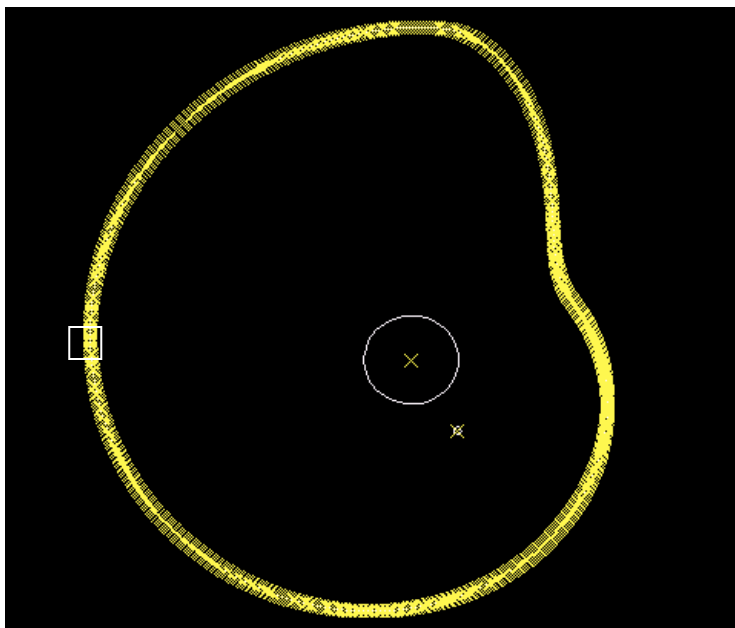

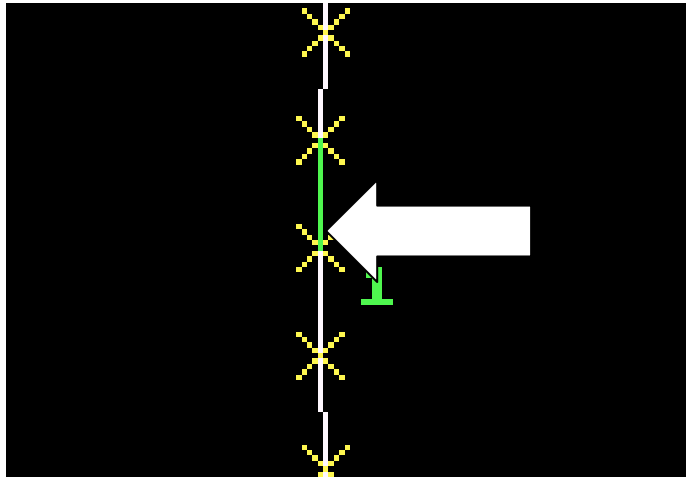

Press **F1** **Select** point mouse arrow to lower end of a line as shown and press left mouse key. Line will turn green as above and put a number at low end of line, the position of the number is the start point. Now point to the line below it and press left mouse key, all of the line will be come green.

Press **ALT** key and letter **F**key at the same time the end of line markers will disappear.

Press **F5** **DISPLAY** press **ENTER** Part will appear at full size on screen

Press **F8** **Save**



Press **F10** **Exit**



Press **F1** or Press **Y** **ENTER** it will now return to **Program** page.



High light .M file press **F4** **Edit**

High light .M file press

**F4**

**Edit**

```
1 Call 1
2 EndMain
3
4 Sub 1
5 Dim Abs
6 Rapid      X -14.44357 Y 1.05070
7 Line       X -14.44446 Y 1.17741
8 Line       X -14.44421 Y 1.30422
9 Line       X -14.44282 Y 1.43111
```

Start of program



```
719 Line     X -14.40565 Y 0.16721
720 Line     X -14.41445 Y 0.29298
721 Line     X -14.42213 Y 0.41891
722 Line     X -14.42868 Y 0.54500
723 Line     X -14.43410 Y 0.67123
724 Line     X -14.43839 Y 0.79760
725 Line     X -14.44155 Y 0.92409
726 Line     X -14.44357 Y 1.05070
727 EndSub
```

End of program

Program has to be **Edited** , to put in tool changes or cutter comp and **Z** moves.

This example will show multiple subroutines.

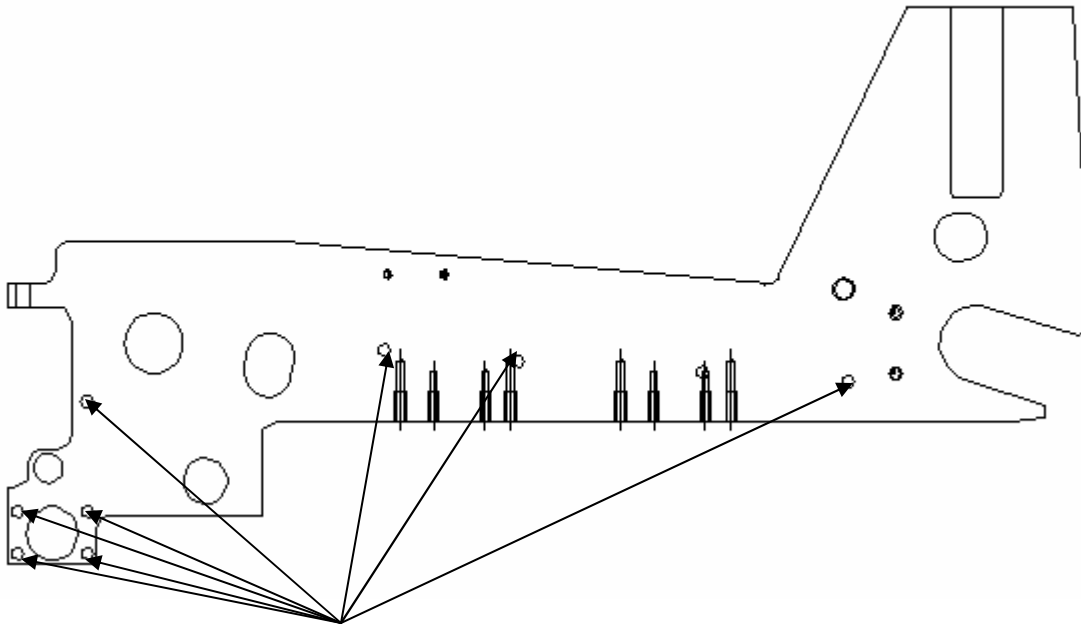

Press **F1** **Select** and pick all holes that are the same size , in this case 8. When going to second set of holes press right key on mouse.

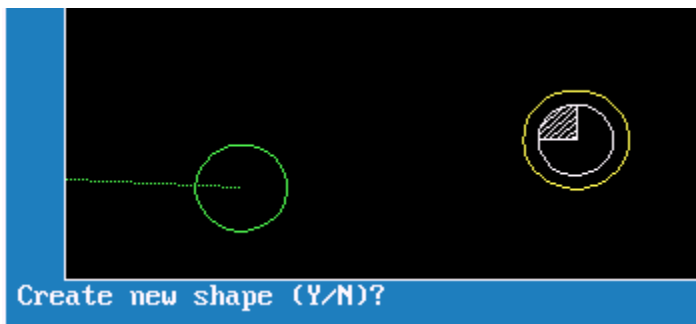

The green circle is the last of previously selected holes. The yellow circle is the one selected with right mouse button and in the bottom left it is asking if this is a new shape, the answer is **Y** .It will put a number 2 next to this hole, meaning this is shape 2.

The print below shows the four shapes of the different sizes holes.

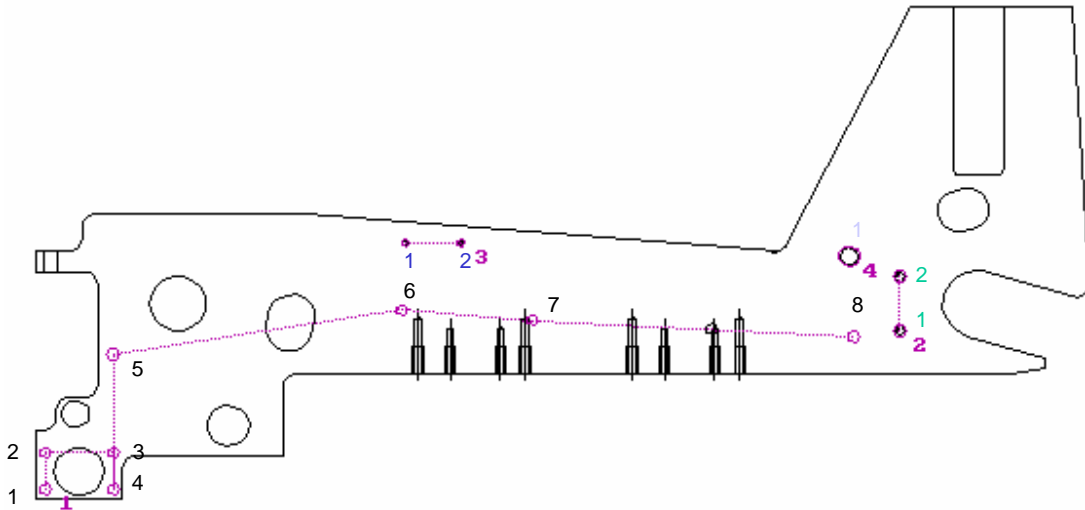

Press **F8** **Save**

Press **F10** **Exit**



Press **F1** or Press **Y** **ENTER** it will now return to **Program page**.

Below show program as it comes from DXF converter.  
 Some work will have to be done in main program to  
 center drill and drill and these holes.

<pre> 1 Call 1 2 Call 2 3 Call 3 4 Call 4 5 EndMain 6 7 Sub 1 8 Dim Abs 9 Rapid      X 1.34375 Y 0.15625 10 Rapid     X 0.15625 Y 0.15625 11 Rapid     X 0.15625 Y 0.84375 12 Rapid     X 1.34375 Y 0.84375 13 Rapid     X 1.34327 Y 2.66153 14 Rapid     X 6.38400 Y 3.50000 15 Rapid     X 8.67900 Y 3.31400 16 Rapid     X 14.30400 Y 3.00000 17 EndSub 18 19 Sub 2 20 Dim Abs 21 Rapid     X 15.10019 Y 3.12200 22 Rapid     X 15.10019 Y 4.12200 23 EndSub 24 25 Sub 3 26 Dim Abs 27 Rapid     X 6.45603 Y 4.75138 28 Rapid     X 7.42403 Y 4.75138 29 EndSub 30 31 Sub 4 32 Dim Abs 33 Rapid     X 14.21138 Y 4.51231 34 EndSub 35 36 &lt;End Of Program&gt; </pre>	<p>Subroutine calls</p> <p>Subroutine for positions of the eight holes numbered in black.</p> <p>Subroutine for positions of the two holes numbered in green.</p> <p>Subroutine for positions of the two holes numbered in blue.</p> <p>Subroutine for positions of the one hole numbered in light blue.</p>
---	--

The following program has been edited to put in drilling cycles and tool changes

```
Dims Abs
Rapid Z0.0000 Tool#0
Rapid X-2.0000 Y-2.0000
Tool#1
BasicDrill Zdepth -0.2000 StartHgt 0.1000 Feed 12.0
Call 1
Call 2
Call 3
Call 4
DrillOff
Rapid Z0.0000 Tool#0
Rapid X-2.0000 Y-2.0000
Tool#2
PeckDrill Zdepth -.5000 StartHgt 0.1000 Peck 0.125 Feed 12.0
Call 1
DrillOff
Rapid Z0.0000 Tool#0
Rapid X-2.0000 Y-2.0000
Tool#3
PeckDrill Zdepth -.5000 StartHgt 0.1000 Peck 0.1250 Feed 11.0
Call 2
DrillOff
Rapid Z0.0000 Tool#0
Rapid X-2.0000 Y-2.0000
Tool#4
PeckDrill Zdepth -0.5000 StartHgt 0.1000 Peck 0.1250 Feed 10.0
Call 3
DrillOff
Rapid Z0.0000 Tool#0
Rapid X-2.0000 Y-2.0000
Tool#5
PeckDrill Zdepth -0.5000 StartHgt 0.1000 Peck 0.1250 Feed 9.0
Call 5
DrillOff
Rapid Z0.0000 Tool#0
Rapid X-2.0000 Y-2.0000
EndMain
```

Dimensions Absolute.  
Rapid to Z0 and Tool 0.  
Rapid Tool change position.  
Call tool #1.  
Drill cycle for Center Drill.  
Calling subroutines to center drill all four sets of holes.

Turn off drilling.

Call tool #2.  
Peck drilling Cycle for eight holes.  
Call eight hole pattern.  
Turn off drilling.



In this example of a full drawing and how to turn off unnecessary information, such as dimensions etc.

The first thing to do is turn off some of the layers so as to leave only the part.

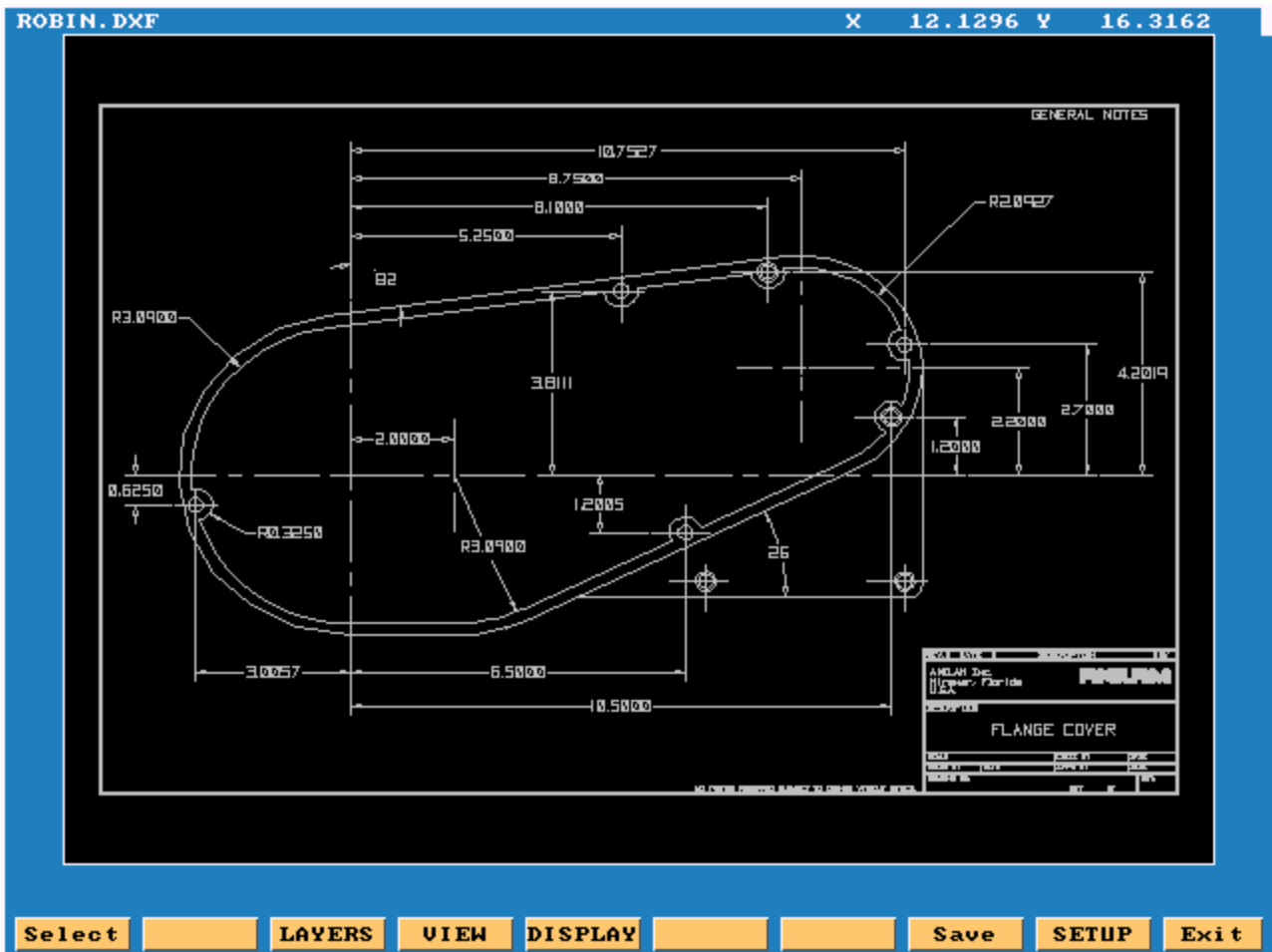

Press **F3** **Layers**

All Layers on  
Invert Layers  
Toggle Layers

High light **Toggle Layers** press

E  
N  
T  
E  
R

Put high light on layers not required and press

E  
N  
T  
E  
R

to turn OFF.



In the drawing shown the only layer left on is #11

Only the part profiles and holes are left.

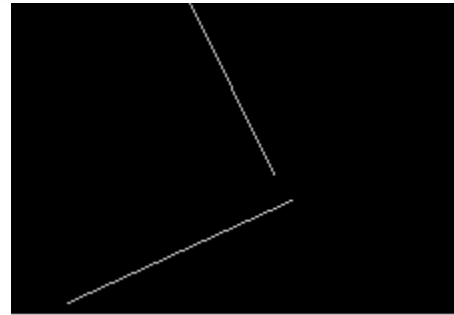
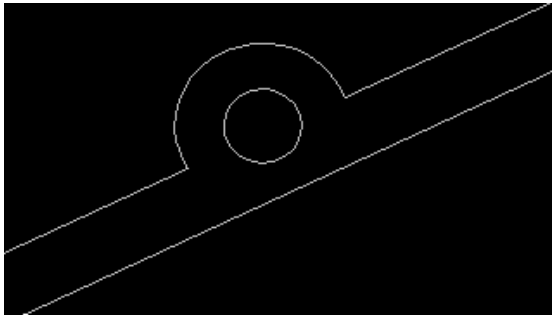
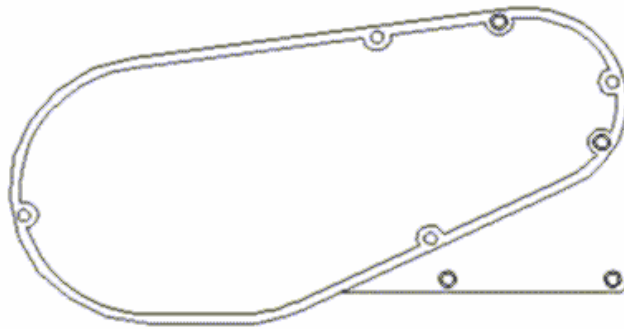

The first picture shows the area with the problem and shows the problem that the line do not meet. The software will take care of this and join the lines together.

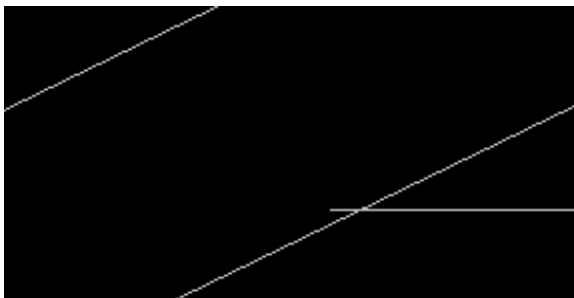

This is another type of problem you see from CAD drawings.